

INCLUSIVE[®]
PROSTHETIC COMPONENTS

Product Catalog
August 2018



888-303-3975 | glidewelldirect.com

GLIDEWELL DIRECT
CLINICAL AND LABORATORY PRODUCTS



By Royal Charter

Certificate of Registration

QUALITY MANAGEMENT SYSTEM - ISO 13485:2003

This is to certify that:

Prismatik Dentalcraft, Inc.
a wholly owned subsidiary of
Glidewell Laboratories
2212 Dupont Drive
Irvine
California
92612
USA

Holds Certificate No:

FM 573328

and operates a Quality Management System which complies with the requirements of ISO 13485:2003 for the following scope:

Design and manufacturing of dental restorative products. Design and development, manufacture, and distribution of dental model scanning and milling systems for dental restorations.

For and on behalf of BSI:

Carlos Pitanga, SVP, System Certification and Compliance

Original Registration Date: 2011-09-02

Effective Date: 2017-08-03

Expiry Date: 2018-12-31



**CMDCAS
Recognized
Registrar**



Page: 1 of 2

...making excellence a habit.™

This certificate remains the property of BSI and shall be returned immediately upon request.
An electronic certificate can be authenticated [online](#). Printed copies can be validated at www.bsigroup.com/ClientDirectory
To be read in conjunction with the scope above or the attached appendix.

Americas Headquarters: BSI Group America Inc., 12950 Worldgate Drive, Suite 800, Herndon, VA 20170-6007 USA
A Member of the BSI Group of Companies.

Introducing Inclusive® Prosthetic Components

Founded in 2006 with the goal of expanding the availability of comprehensive dental implant therapy to patients across the economic spectrum, Prismatik Dentalcraft reduces the component and restorative cost of treatment while maintaining the highest standard of quality. Having assembled a diverse team of experts with decades of combined experience in the design, engineering, and manufacture of dental implants, along with a staff of highly respected researchers, material scientists, clinical specialists, restorative doctors, and dental technicians, we at Prismatik are dedicated to advancing implant dentistry by combining proven treatment protocols with cutting-edge materials, technologies, and techniques.

Prosthetic components for the Inclusive® Tapered Implant System include a wide array of esthetic and multi-unit titanium abutments, along with analogs, screws, temporary and UCLA abutments, digital and conventional transfer copings, and more. Prismatik Dentalcraft also has FDA 510(k) clearance for prosthetic connections that are compatible with several of the industry's other leading implant manufacturers. Prosthetic components manufactured by Prismatik Dentalcraft are produced in an ISO 13485 certified environment in Irvine, California, operating under U.S. Food and Drug Administration Current Good Manufacturing Practices (CGMPs). This ensures tight tolerances, precision machining, state-of-the-art processing and cleaning, and extensive validation testing — from fatigue strength assessment to packaging integrity analysis. Uniform component costs across systems allow for predictable pricing. The result is a product that offers immediate value and lasting quality.

From its beginnings until today, Prismatik Dentalcraft has experienced an ever-growing demand in support of its vision to make dental implant therapy more accessible to patients around the globe. This growth has enabled the company to consistently expand and improve its offerings even in a time of widespread economic challenge. The Inclusive brand has quickly established itself as a trusted name within the industry, and Prismatik Dentalcraft as a manufacturer at the forefront of dental technology.

Thank you for choosing Prismatik. You can place your trust in us.



Copyright © 2018, Prismatik Dentalcraft, Inc. Prismatik Dentalcraft, Inc. is not responsible for any damages or other liabilities (including attorney fees) resulting, or claimed to result in whole or in part, from actual or alleged problems arising out of the use of this information. The techniques, procedures and theories presented herein are provided in good faith and believed to be correct as of the date hereof. Any dental professional viewing this presentation must make his or her own decisions about the use of the materials and techniques for specific situations.

No representations as to the completeness or accuracy of this information is given, and no representations or warranties, either expressed or implied, of merchantability, fitness for a particular purpose or of any other nature are made here under with respect to the information or the product to which information refers.

Contents

6 Inclusive® Tapered Implant System

Implant components compatible with the following third-party implant systems:

- 12 BIOMET 3i™ Certain®
- 16 CAMLOG® SCREW-LINE
- 20 DENTSPLY Implants ANKYLOS® C/X
- 22 DENTSPLY Implants ASTRA TECH Implant System®
- 26 Hiossen® HG System
- 29 Keystone Dental PrimaConnex®
- 30 MegaGen AnyRidge® Implant System
- 32 Neoss® Implant System
- 33 Nobel Biocare Brånemark System®
- 35 Nobel Biocare NobelActive®
- 38 Nobel Biocare NobelReplace®
- 43 Straumann® Bone Level
- 46 Straumann® Tissue Level
- 48 Zimmer Dental Screw-Vent®
- 50 Inclusive Prosthetic Kit
- 51 Laboratory Scanning Abutment Kit

52 Parts Index

60 Product Packaging

61 Policies & Warranty



*Inclusive is a registered trademark of Prismatic Dentalcraft, Inc.
BIOMET 3i is a trademark and CERTAIN a registered trademark of BIOMET 3i, LLC.
CAMLOG is a registered trademark of Camlog Biotechnologies AG.
ANKYLOS is a registered trademark of DeguDent GMBH LLC.
ASTRA TECH IMPLANT SYSTEM is a registered trademark of Dentsply IH AB LLC.
HIOSSSEN is a registered trademark of OSSTEM IMPLANT CO., LTD.
PRIMACONNEX is a registered trademark of Keystone Dental, Inc.
AnyRidge is a registered trademark of MEGAGEN IMPLANT CO., LTD.
NEOSS is a registered trademark of Neoss Limited.
Brånemark System, NobelActive, and NobelReplace are registered trademarks of the Nobel Biocare group.
STRAUMANN is a registered trademark of Straumann Holding AG.
SCREW-VENT is a registered trademark of Zimmer Dental Inc.*

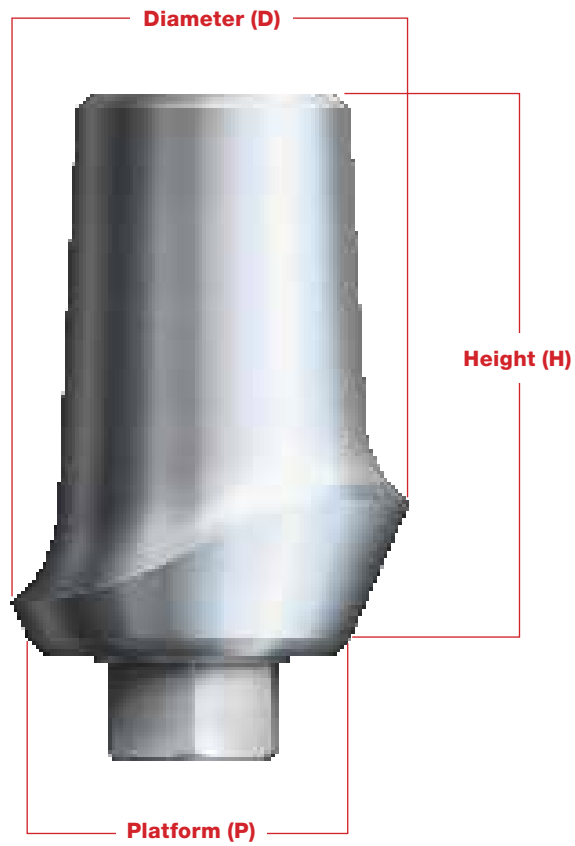
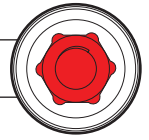

Ø3.2 mm

Ø3.7 mm

Ø4.2 mm

Ø4.7 mm

Ø5.2 mm

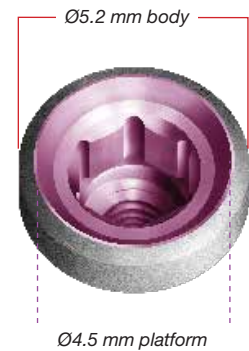
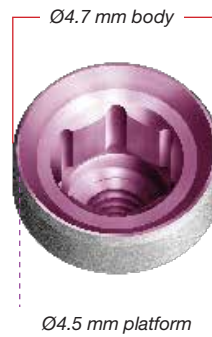
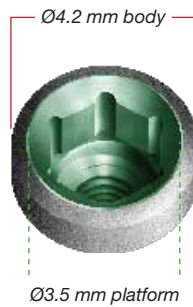
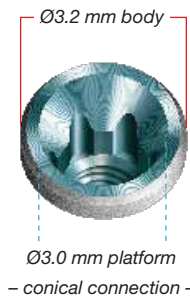

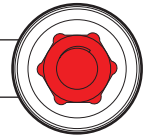

IMPLANT ANALOGS



Description	Code	Price
Inclusive® Tapered Implant Analog 3.0 mmP	70-1072-PRC0055	\$12
Inclusive® Tapered Implant Analog 3.5 mmP	70-1072-PRC0015	\$12
Inclusive® Tapered Implant Analog 4.5 mmP	70-1072-PRC0017	\$12

IMPRESSION TRANSFERS



Inclusive® Tapered Implant Transfer Coping, Closed-Tray, 3.0 mmP x 3.2 mmD	70-1072-PRC0051	\$28
Inclusive® Tapered Implant Transfer Coping, Closed-Tray, 3.0 mmP x 3.7 mmD	70-1072-PRC0053	\$28
Inclusive® Tapered Implant Transfer Coping, Closed-Tray, 3.5 mmP x 3.5 mmD	70-1072-PRC0007	\$28
Inclusive® Tapered Implant Transfer Coping, Closed-Tray, 3.5 mmP x 4.7 mmD	70-1072-PRC0009	\$28
Inclusive® Tapered Implant Transfer Coping, Closed-Tray, 4.5 mmP x 4.5 mmD	70-1072-PRC0011	\$28
Inclusive® Tapered Implant Transfer Coping, Closed-Tray, 4.5 mmP x 5.7 mmD	70-1072-PRC0013	\$28
<i>(Closed-Tray Transfer Copings include Closed-Tray Screw.)</i>		
Inclusive® Tapered Implant Transfer Coping, Open-Tray, 3.0 mmP x 3.2 mmD	70-1072-PRC0052	\$28
Inclusive® Tapered Implant Transfer Coping, Open-Tray, 3.0 mmP x 3.7 mmD	70-1072-PRC0054	\$28
Inclusive® Tapered Implant Transfer Coping, Open-Tray, 3.5 mmP x 3.5 mmD	70-1072-PRC0006	\$28
Inclusive® Tapered Implant Transfer Coping, Open-Tray, 3.5 mmP x 4.7 mmD	70-1072-PRC0008	\$28
Inclusive® Tapered Implant Transfer Coping, Open-Tray, 4.5 mmP x 4.5 mmD	70-1072-PRC0010	\$28
Inclusive® Tapered Implant Transfer Coping, Open-Tray, 4.5 mmP x 5.7 mmD	70-1072-PRC0012	\$28
<i>(Open-Tray Transfer Copings include Open-Tray Screw and Guide Pin.)</i>		

SCANNING ABUTMENTS



<i>Clinical Use (radiopaque)</i>		
Inclusive® Tapered Implant Clinical Scanning Abutment, Anterior, 3.0 mmP	70-1073-PRA0051	\$15
Inclusive® Tapered Implant Clinical Scanning Abutment, Anterior, 3.5 mmP	70-1073-PRA0042	\$15
Inclusive® Tapered Implant Clinical Scanning Abutment, Anterior, 4.5 mmP	70-1073-PRA0043	\$15

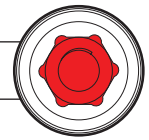

SCANNING ABUTMENTS

Description Code Price



Clinical Use (radiopaque)

Inclusive® Tapered Implant Clinical Scanning Abutment, Posterior, 3.0 mmP 70-1073-PRA0050 \$15

Inclusive® Tapered Implant Clinical Scanning Abutment, Posterior, 3.5 mmP 70-1073-PRA0040 \$15



Inclusive® Tapered Implant Clinical Scanning Abutment, Posterior, 4.5 mmP 70-1073-PRA0041 \$15



Laboratory Packs (radiolucent)

Inclusive® Tapered Implant Laboratory Scanning Abutment 3.0 mmP (3-pack) 70-1073-PRA0049 \$45

Inclusive® Tapered Implant Laboratory Scanning Abutment 3.5 mmP (3-pack) 70-1073-PRA0033 \$45



Inclusive® Tapered Implant Laboratory Scanning Abutment 4.5 mmP (3-pack) 70-1073-PRA0034 \$45



Blue Light Scanner Laboratory Packs (radiolucent)

Inclusive® Tapered Implant Laboratory Scanning Abutment† 3.0 mmP (3-pack) 70-1073-PRA0066 \$50

Inclusive® Tapered Implant Laboratory Scanning Abutment† 3.5 mmP (3-pack) 70-1073-PRA0067 \$50

Inclusive® Tapered Implant Laboratory Scanning Abutment† 4.5 mmP (3-pack) 70-1073-PRA0068 \$50



†for Blue Light Scanners

(Scanning Abutments include Captured Screw.)

TEMPORARY ABUTMENTS



Inclusive® Tapered Implant Temporary Abutment 3.0 mmP 70-1073-PRA0048 \$30

Inclusive® Tapered Implant Temporary Abutment 3.5 mmP 70-1073-PRA0022 \$30

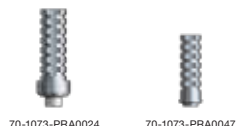

Inclusive® Tapered Implant Temporary Abutment 4.5 mmP 70-1073-PRA0024 \$30

Inclusive® Tapered Implant Temporary Abutment, Non-Engaging, 3.0 mmP 70-1073-PRA0047 \$30

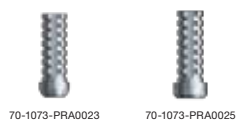





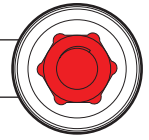

Inclusive® Tapered Implant Temporary Abutment, Non-Engaging, 3.5 mmP 70-1073-PRA0023 \$30

Inclusive® Tapered Implant Temporary Abutment, Non-Engaging, 4.5 mmP 70-1073-PRA0025 \$30

(Temporary Abutments include Titanium Screw and Guide Pin.)

















TITANIUM ABUTMENTS

Description		Code	Price
	Inclusive® Tapered Implant Titanium Abutment 3.0 mmP x 4.5 mmH	70-1073-PRA0052	\$35
	Inclusive® Tapered Implant Titanium Abutment 3.5 mmP x 4.5 mmH	70-1073-PRA0045	\$35
	Inclusive® Tapered Implant Titanium Abutment 4.5 mmP x 4.5 mmH	70-1073-PRA0046	\$35
	Inclusive® Tapered Implant Titanium Abutment 3.0 mmP x 6 mmH	70-1073-PRA0053	\$35
	Inclusive® Tapered Implant Titanium Abutment 3.5 mmP x 6 mmH	70-1073-PRA0006	\$35
	Inclusive® Tapered Implant Titanium Abutment 4.5 mmP x 6 mmH	70-1073-PRA0008	\$35

(Titanium Screw sold separately; please see page 9.)







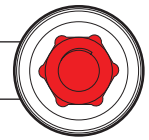

TITANIUM ESTHETIC ABUTMENTS

	Inclusive® Tapered Implant 15° Titanium Esthetic Abutment, Anterior, 3.0 mmP x 1.5 mmH	70-1073-PRA0054	\$85
	Inclusive® Tapered Implant 15° Titanium Esthetic Abutment, Anterior, 3.0 mmP x 2.3 mmH	70-1073-PRA0059	\$85
	Inclusive® Tapered Implant 15° Titanium Esthetic Abutment, Anterior, 3.5 mmP x 1.5 mmH	70-1073-PRA0031	\$85
	Inclusive® Tapered Implant 15° Titanium Esthetic Abutment, Anterior, 3.5 mmP	70-1073-PRA0009	\$85
	Inclusive® Tapered Implant 15° Titanium Esthetic Abutment, Anterior, 4.5 mmP x 1.5 mmH	70-1073-PRA0062	\$85
	Inclusive® Tapered Implant 15° Titanium Esthetic Abutment, Anterior, 4.5 mmP	70-1073-PRA0010	\$85
	Inclusive® Tapered Implant 15° Titanium Esthetic Abutment, Posterior, 4.5 mmP	70-1073-PRA0013	\$85
	Inclusive® Tapered Implant Titanium Esthetic Abutment, Anterior, 3.0 mmP x 1.5 mmH	70-1073-PRA0055	\$85
	Inclusive® Tapered Implant Titanium Esthetic Abutment, Anterior, 3.0 mmP x 2.3 mmH	70-1073-PRA0060	\$85
	Inclusive® Tapered Implant Titanium Esthetic Abutment, Anterior, 3.5 mmP x 1.5 mmH	70-1073-PRA0032	\$85
	Inclusive® Tapered Implant Titanium Esthetic Abutment, Anterior, 3.5 mmP	70-1073-PRA0011	\$85
	Inclusive® Tapered Implant Titanium Esthetic Abutment, Anterior, 4.5 mmP x 1.5 mmH	70-1073-PRA0063	\$85
	Inclusive® Tapered Implant Titanium Esthetic Abutment, Anterior, 4.5 mmP	70-1073-PRA0012	\$85
	Inclusive® Tapered Implant Titanium Esthetic Abutment, Posterior, 4.5 mmP	70-1073-PRA0014	\$85
	Inclusive® Tapered Implant Titanium Esthetic Abutment, Posterior, Wide, 4.5 mmP	70-1073-PRA0015	\$85

(Esthetic Abutments include Titanium Screw.)











UCLA ABUTMENTS

Description		Code	Price
	Inclusive® Tapered Implant UCLA Gold Abutment 3.0 mmP	70-1073-PRA0056	\$100
	Inclusive® Tapered Implant UCLA Gold Abutment 3.5 mmP	70-1073-PRA0027	\$100
	Inclusive® Tapered Implant UCLA Gold Abutment 4.5 mmP	70-1073-PRA0029	\$100
70-1073-PRA0056	70-1073-PRA0027	70-1073-PRA0029	
	Inclusive® Tapered Implant UCLA Plastic Abutment 3.0 mmP	70-1073-PRA0058	\$35
	Inclusive® Tapered Implant UCLA Plastic Abutment 3.5 mmP	70-1073-PRA0018	\$35
	Inclusive® Tapered Implant UCLA Plastic Abutment 4.5 mmP	70-1073-PRA0020	\$35
70-1073-PRA0058	70-1073-PRA0018	70-1073-PRA0020	
	Inclusive® Tapered Implant UCLA Plastic Abutment, Non-Engaging, 3.0 mmP	70-1073-PRA0057	\$35
	Inclusive® Tapered Implant UCLA Plastic Abutment, Non-Engaging, 3.5 mmP	70-1073-PRA0019	\$35
	Inclusive® Tapered Implant UCLA Plastic Abutment, Non-Engaging, 4.5 mmP	70-1073-PRA0021	\$35
70-1073-PRA0057	70-1073-PRA0019	70-1073-PRA0021	







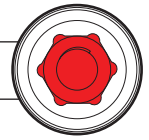









(UCLA Abutments include Titanium Screw and Guide Pin.)

TITANIUM SCREWS AND GUIDE PINS

	Inclusive® Tapered Implant Titanium Screw 3.0 mmP	70-1072-PRC0058	\$12
	Inclusive® Tapered Implant Titanium Screw 3.0 mmP (5-pack)	70-1072-PRC0057	\$50
70-1072-PRC0058	70-1072-PRC0001		
70-1072-PRC0057	70-1072-PRC0003		
	Inclusive® Tapered Implant Titanium Screw 3.5/4.5 mmP	70-1072-PRC0001	\$12
	Inclusive® Tapered Implant Titanium Screw 3.5/4.5 mmP (5-pack)	70-1072-PRC0003	\$50
70-1072-PRC0056	70-1072-PRC0002		
	Inclusive® Tapered Implant Guide Pin 3.0 mmP (5-pack)	70-1072-PRC0056	\$50
	Inclusive® Tapered Implant Guide Pin 3.5/4.5 mmP (5-pack)	70-1072-PRC0002	\$50
70-1072-PRC0005	70-1072-PRC0004		
	Inclusive® Tapered Implant Closed-Tray Transfer Screw	70-1072-PRC0005	\$15
	Inclusive® Tapered Implant Open-Tray Transfer Screw	70-1072-PRC0004	\$15



MULTI-UNIT ABUTMENTS

	Description	Code	Price
	Inclusive® Tapered Implant Multi-Unit Abutment 3.0 mmP x 1.5 mmH	70-1074-PRS0040	\$100
	Inclusive® Tapered Implant Multi-Unit Abutment 3.0 mmP x 2.5 mmH	70-1074-PRS0041	\$100
	Inclusive® Tapered Implant Multi-Unit Abutment 3.0 mmP x 3.5 mmH	70-1074-PRS0042	\$100
	Inclusive® Tapered Implant Multi-Unit Abutment 3.5 mmP x 1 mmH	70-1074-PRS0009	\$100
	Inclusive® Tapered Implant Multi-Unit Abutment 3.5 mmP x 2 mmH	70-1074-PRS0010	\$100
	Inclusive® Tapered Implant Multi-Unit Abutment 3.5 mmP x 3 mmH	70-1074-PRS0065	\$100
	Inclusive® Tapered Implant Multi-Unit Abutment 3.5 mmP x 5 mmH	70-1074-PRS0066	\$100
	Inclusive® Tapered Implant Multi-Unit Abutment 4.5 mmP x 1 mmH	70-1074-PRS0011	\$100
	Inclusive® Tapered Implant Multi-Unit Abutment 4.5 mmP x 2 mmH	70-1074-PRS0012	\$100
	Inclusive® Tapered Implant Multi-Unit Abutment 4.5 mmP x 3 mmH	70-1074-PRS0013	\$100
	Inclusive® Tapered Implant Multi-Unit Abutment 4.5 mmP x 5 mmH	70-1074-PRS0014	\$100
	<i>(Prosthetic Screw sold separately; please see page 11.)</i>		
	Inclusive® Tapered Implant 17° Multi-Unit Abutment 3.5 mmP x 2 mmH	70-1074-PRS0001	\$100
	Inclusive® Tapered Implant 17° Multi-Unit Abutment 3.5 mmP x 3 mmH	70-1074-PRS0002	\$100
	Inclusive® Tapered Implant 17° Multi-Unit Abutment 4.5 mmP x 2 mmH	70-1074-PRS0003	\$100
	Inclusive® Tapered Implant 17° Multi-Unit Abutment 4.5 mmP x 3 mmH	70-1074-PRS0004	\$100
	Inclusive® Tapered Implant 17° Multi-Unit Abutment 4.5 mmP x 5 mmH	70-1074-PRS0005	\$100
	Inclusive® Tapered Implant 30° Multi-Unit Abutment 3.5 mmP x 3 mmH	70-1074-PRS0006	\$100
	Inclusive® Tapered Implant 30° Multi-Unit Abutment 4.5 mmP x 3 mmH	70-1074-PRS0007	\$100
	Inclusive® Tapered Implant 30° Multi-Unit Abutment 4.5 mmP x 5 mmH	70-1074-PRS0008	\$100
	<i>(Angled Multi-Unit Abutments include Angled Abutment Screw. Prosthetic Screw sold separately; please see page 11.)</i>		

MULTI-UNIT TITANIUM SCREWS









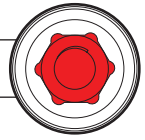









Inclusive® Angled Multi-Unit Abutment Screw	70-1074-PRS0031	\$12
---	-----------------	------

INCLUSIVE® Tapered Implant System

Unigrip is a trademark of the Nobel Biocare group.



MULTI-UNIT ABUTMENT ACCESSORIES



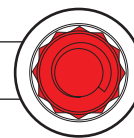

	Description	Code	Price
	Inclusive® Multi-Unit Abutment Analog	70-1074-PRS0016	\$15
	Inclusive® Multi-Unit Driver	70-1074-PRS0028	\$40
	Inclusive® Multi-Unit Gold/Plastic Coping	70-1074-PRS0030	\$100
	Inclusive® Multi-Unit Gold Bar Coping	70-1074-PRS0018	\$100
	Inclusive® Multi-Unit Impression Coping, Closed-Tray	70-1074-PRS0021	\$25
	Inclusive® Multi-Unit Plastic Coping with Prosthetic Screw .048" Hex	70-1074-PRS0068	\$35
	with Prosthetic Screw .050" Hex	70-1074-PRS0067	
	with Prosthetic Screw 1.0 mm Hex	70-1074-PRS0071	
	with Prosthetic Screw SCS	70-1074-PRS0070	
	with Prosthetic Screw - Unigrip™ Driver	70-1074-PRS0069	
	Inclusive® Multi-Unit Impression Coping, Open-Tray		\$25
	with Guide Pin .048" Hex	70-1074-PRS0053	
	with Guide Pin .050" Hex	70-1074-PRS0052	
	with Guide Pin 1.0 mm Hex	70-1074-PRS0055	
	with Guide Pin SCS	70-1074-PRS0054	
	with Guide Pin - Unigrip™ Driver	70-1074-PRS0022	
	Inclusive® Multi-Unit Temporary Healing Cap		\$15
	with Prosthetic Screw .048" Hex	70-1074-PRS0043	
	with Prosthetic Screw .050" Hex	70-1074-PRS0015	
	with Prosthetic Screw 1.0 mm Hex	70-1074-PRS0046	
	with Prosthetic Screw SCS	70-1074-PRS0045	
	with Prosthetic Screw - Unigrip™ Driver	70-1074-PRS0044	
	Inclusive® Multi-Unit Coping 4.5 mmH, Non-Engaging		\$45
	with Prosthetic Screw .048" Hex	70-1074-PRS0047	
	with Prosthetic Screw .050" Hex	70-1073-PRA0037	
	with Prosthetic Screw 1.0 mm Hex	70-1074-PRS0050	
	with Prosthetic Screw SCS	70-1074-PRS0049	
	with Prosthetic Screw - Unigrip™ Driver	70-1074-PRS0048	
	Inclusive® Multi-Unit Guide Pin		\$15
	.048" Hex	70-1074-PRS0035	
	.050" Hex	70-1074-PRS0061	
	1.0 mm Hex	70-1074-PRS0036	
	SCS	70-1074-PRS0037	
	Unigrip™ Driver	70-1074-PRS0019	
	Inclusive® Multi-Unit Titanium Temporary		\$30
	with Prosthetic Screw .048" Hex	70-1074-PRS0056	
	with Prosthetic Screw .050" Hex	70-1074-PRS0025	
	with Prosthetic Screw 1.0 mm Hex	70-1074-PRS0059	
	with Prosthetic Screw SCS	70-1074-PRS0058	
	with Prosthetic Screw - Unigrip™ Driver	70-1074-PRS0057	
	Inclusive® Multi-Unit Prosthetic Screw		\$12
	.048" Hex	70-1047-COM0153	
	.050" Hex	70-1072-PRC0014	
	1.0 mm Hex	70-1072-PRC0046	
	SCS	70-1052-COM0088	
	Unigrip™ Driver	70-1072-PRC0043	

Implant components compatible with: **BIOMET 3i™ Certain®**

















BIOMET 3i and Certain are trademarks of BIOMET 3i, LLC.



IMPLANT ANALOGS

Description (with Platform Size)		Code	Price
 70-1047-COM0013	Inclusive® Implant Analog (5-pack)* 3.4 mm	70-1047-COM0013	\$60
 70-1047-COM0014	Inclusive® Implant Analog (5-pack)* 4.1 mm	70-1047-COM0014	\$60
 70-1047-COM0015	Inclusive® Implant Analog (5-pack)* 5.0 mm	70-1047-COM0015	\$60
 70-1047-COM0016	Inclusive® Implant Analog (5-pack)* 6.0 mm	70-1047-COM0016	\$60

SCANNING ABUTMENTS

 70-1047-COM0118	<i>Clinical Use (radiopaque)</i> Inclusive® Clinical Scanning Abutment, Anterior* 3.4 mm	70-1047-COM0118	\$15
 70-1047-COM0119	Inclusive® Clinical Scanning Abutment, Anterior* 4.1 mm	70-1047-COM0119	\$15
 70-1047-COM0120	Inclusive® Clinical Scanning Abutment, Anterior* 5.0 mm	70-1047-COM0120	\$15
 70-1047-COM0121	Inclusive® Clinical Scanning Abutment, Anterior* 6.0 mm	70-1047-COM0121	\$15
 70-1047-COM0187	<i>Clinical Use (radiopaque)</i> Inclusive® Clinical Scanning Abutment, Posterior* 3.4 mm	70-1047-COM0187	\$15
 70-1047-COM0188	Inclusive® Clinical Scanning Abutment, Posterior* 4.1 mm	70-1047-COM0188	\$15
 70-1047-COM0189	Inclusive® Clinical Scanning Abutment, Posterior* 5.0 mm	70-1047-COM0189	\$15
 70-1047-COM0190	Inclusive® Clinical Scanning Abutment, Posterior* 6.0 mm	70-1047-COM0190	\$15
 70-1047-COM0175	<i>Laboratory Packs (radiolucent)</i> Inclusive® Laboratory Scanning Abutment (3-pack)* 3.4 mm	70-1047-COM0175	\$45
 70-1047-COM0176	Inclusive® Laboratory Scanning Abutment (3-pack)* 4.1 mm	70-1047-COM0176	\$45
 70-1047-COM0177	Inclusive® Laboratory Scanning Abutment (3-pack)* 5.0 mm	70-1047-COM0177	\$45
 70-1047-COM0178	Inclusive® Laboratory Scanning Abutment (3-pack)* 6.0 mm	70-1047-COM0178	\$45
 70-1047-COM0200	<i>Blue Light Scanner Laboratory Packs (radiolucent)</i> Inclusive® Laboratory Scanning Abutment† (3-pack)* 3.4 mm	70-1047-COM0200	\$45
 70-1047-COM0201	Inclusive® Laboratory Scanning Abutment† (3-pack)* 4.1 mm	70-1047-COM0201	\$45
 70-1047-COM0202	Inclusive® Laboratory Scanning Abutment† (3-pack)* 5.0 mm	70-1047-COM0202	\$45
 70-1047-COM0203	Inclusive® Laboratory Scanning Abutment† (3-pack)* 6.0 mm	70-1047-COM0203	\$45

†for Blue Light Scanners

(Scanning Abutments include Captured Screw.)







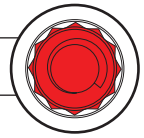

*compatible with: Biomet 3i™ Certain®

Implant components compatible with: **BIOMET 3i™ Certain®**

BIOMET 3i and Certain are trademarks of BIOMET 3i, LLC.



BITE VERIFICATION CYLINDERS

Description (with Platform Size)		Code	Price
	Inclusive® Bite Verification Cylinder* 3.4 mm	70-1047-COM0130	\$30
	Inclusive® Bite Verification Cylinder* 4.1 mm	70-1047-COM0131	\$30
	Inclusive® Bite Verification Cylinder* 5.0 mm	70-1047-COM0132	\$30
	Inclusive® Bite Verification Cylinder* 6.0 mm	70-1047-COM0133	\$30
	Inclusive® Bite Verification Cylinder, Non-Engaging* 3.4 mm	70-1047-COM0126	\$30
	Inclusive® Bite Verification Cylinder, Non-Engaging* 4.1 mm	70-1047-COM0127	\$30
	Inclusive® Bite Verification Cylinder, Non-Engaging* 5.0 mm	70-1047-COM0128	\$30
	Inclusive® Bite Verification Cylinder, Non-Engaging* 6.0 mm	70-1047-COM0129	\$30





(Bite Verification Cylinders include Titanium Screw and Guide Pin.)

TITANIUM ABUTMENTS

	Inclusive® Titanium Abutment 4.5 mmH* 3.4 mm	70-1047-COM0084	\$35
	Inclusive® Titanium Abutment 4.5 mmH* 4.1 mm	70-1047-COM0086	\$35
	Inclusive® Titanium Abutment 4.5 mmH* 5.0 mm	70-1047-COM0088	\$35
	Inclusive® Titanium Abutment 4.5 mmH* 6.0 mm	70-1047-COM0090	\$35
	Inclusive® Titanium Abutment 6 mmH* 3.4 mm	70-1047-COM0005	\$35
	Inclusive® Titanium Abutment 6 mmH* 4.1 mm	70-1047-COM0006	\$35
	Inclusive® Titanium Abutment 6 mmH* 5.0 mm	70-1047-COM0007	\$35
	Inclusive® Titanium Abutment 6 mmH* 6.0 mm	70-1047-COM0008	\$35
	Inclusive® Titanium Abutment 4.5 mmH, Non-Engaging* 3.4 mm	70-1047-COM0092	\$35
	Inclusive® Titanium Abutment 4.5 mmH, Non-Engaging* 4.1 mm	70-1047-COM0094	\$35
	Inclusive® Titanium Abutment 4.5 mmH, Non-Engaging* 5.0 mm	70-1047-COM0096	\$35
	Inclusive® Titanium Abutment 4.5 mmH, Non-Engaging* 6.0 mm	70-1047-COM0098	\$35

(Titanium Screw sold separately; please see page 14.)

TITANIUM ESTHETIC ABUTMENTS

	Inclusive® 15° Titanium Esthetic Abutment, Anterior* 3.4 mm	70-1047-COM0154	\$85
	Inclusive® 15° Titanium Esthetic Abutment, Anterior* 4.1 mm	70-1047-COM0155	\$85
	Inclusive® 15° Titanium Esthetic Abutment, Anterior* 5.0 mm	70-1047-COM0156	\$85
	Inclusive® 15° Titanium Esthetic Abutment, Posterior* 4.1 mm	70-1047-COM0157	\$85
	Inclusive® 15° Titanium Esthetic Abutment, Posterior* 5.0 mm	70-1047-COM0158	\$85

(Esthetic Abutments include Titanium Screw.)





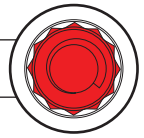

*compatible with: Biomet 3i™ Certain®

Implant components compatible with: **BIOMET 3i™ Certain®**

BIOMET 3i and Certain are trademarks of BIOMET 3i, LLC.



TITANIUM ESTHETIC ABUTMENTS

Description (with Platform Size)		Code	Price
	Inclusive® Titanium Esthetic Abutment, Anterior* 3.4 mm	70-1047-COM0159	\$85
	Inclusive® Titanium Esthetic Abutment, Anterior* 4.1 mm	70-1047-COM0160	\$85
	Inclusive® Titanium Esthetic Abutment, Anterior* 5.0 mm	70-1047-COM0161	\$85
	Inclusive® Titanium Esthetic Abutment, Posterior* 4.1 mm	70-1047-COM0162	\$85
	Inclusive® Titanium Esthetic Abutment, Posterior* 5.0 mm	70-1047-COM0163	\$85
	Inclusive® Titanium Esthetic Abutment, Posterior* 6.0 mm	70-1047-COM0164	\$85

(Esthetic Abutments include Titanium Screw.)

TITANIUM ABUTMENT BLANKS



	Inclusive® Titanium Abutment Blank* 3.4 mm	70-1047-COM0054	\$30
	Inclusive® Titanium Abutment Blank* 4.1 mm	70-1047-COM0055	\$30
	Inclusive® Titanium Abutment Blank* 5.0 mm	70-1047-COM0056	\$30
	Inclusive® Titanium Abutment Blank* 6.0 mm	70-1047-COM0057	\$30

UCLA PLASTIC ABUTMENTS

	Inclusive® UCLA Plastic Abutment* 3.4 mm	70-1047-COM0165	\$35
	Inclusive® UCLA Plastic Abutment* 4.1 mm	70-1047-COM0166	\$35
	Inclusive® UCLA Plastic Abutment* 5.0 mm	70-1047-COM0167	\$35
	Inclusive® UCLA Plastic Abutment* 6.0 mm	70-1047-COM0168	\$35
	Inclusive® UCLA Plastic Abutment, Non-Engaging* 3.4 mm	70-1047-COM0169	\$35
	Inclusive® UCLA Plastic Abutment, Non-Engaging* 4.1 mm	70-1047-COM0170	\$35
	Inclusive® UCLA Plastic Abutment, Non-Engaging* 5.0 mm	70-1047-COM0171	\$35
	Inclusive® UCLA Plastic Abutment, Non-Engaging* 6.0 mm	70-1047-COM0172	\$35

(UCLA Abutments include Titanium Screw and Guide Pin.)

TITANIUM SCREWS AND GUIDE PINS

	Inclusive® Titanium Screw* 3.4/4.1/5.0/6.0 mm	70-1047-COM0117	\$12
	Inclusive® Titanium Screw (5-pack)* 3.4/4.1/5.0/6.0 mm	70-1047-COM0029	\$50
	Inclusive® Guide Pin (5-pack)* 3.4/4.1/5.0/6.0 mm	70-1047-COM0112	\$50







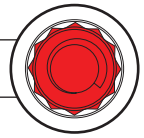











*compatible with: Biomet 3i™ Certain®

Implant components compatible with: **BIOMET 3i™ Certain®**

BIOMET 3i and Certain are trademarks of BIOMET 3i, LLC.



MULTI-UNIT ABUTMENTS

Description (with Platform Size)		Code	Price
	Inclusive® Multi-Unit Abutment 1 mmH* 3.4 mm	70-1047-COM0134	\$100
	Inclusive® Multi-Unit Abutment 2 mmH* 3.4 mm	70-1047-COM0135	\$100
	Inclusive® Multi-Unit Abutment 3 mmH* 3.4 mm	70-1047-COM0136	\$100
70-1047-COM0134			
70-1047-COM0135			
70-1047-COM0136			
	Inclusive® Multi-Unit Abutment 1 mmH* 4.1 mm	70-1047-COM0137	\$100
	Inclusive® Multi-Unit Abutment 2 mmH* 4.1 mm	70-1047-COM0138	\$100
	Inclusive® Multi-Unit Abutment 3 mmH* 4.1 mm	70-1047-COM0139	\$100
	Inclusive® Multi-Unit Abutment 5 mmH* 4.1 mm	70-1047-COM0140	\$100
70-1047-COM0137			
70-1047-COM0138			
70-1047-COM0139			
70-1047-COM0140			
	Inclusive® Multi-Unit Abutment 1 mmH* 5.0 mm	70-1047-COM0141	\$100
	Inclusive® Multi-Unit Abutment 2 mmH* 5.0 mm	70-1047-COM0142	\$100
	Inclusive® Multi-Unit Abutment 3 mmH* 5.0 mm	70-1047-COM0143	\$100
70-1047-COM0141			
70-1047-COM0142			
70-1047-COM0143			
<i>(Prosthetic Screw sold separately; please see page 11.)</i>			
	Inclusive® 17° Multi-Unit Abutment 2 mmH* 3.4 mm	70-1047-COM0144	\$100
	Inclusive® 17° Multi-Unit Abutment 3 mmH* 3.4 mm	70-1047-COM0145	\$100
	Inclusive® 17° Multi-Unit Abutment 2 mmH* 4.1 mm	70-1047-COM0146	\$100
	Inclusive® 17° Multi-Unit Abutment 3 mmH* 4.1 mm	70-1047-COM0147	\$100
	Inclusive® 17° Multi-Unit Abutment 2 mmH* 5.0 mm	70-1047-COM0148	\$100
	Inclusive® 17° Multi-Unit Abutment 3 mmH* 5.0 mm	70-1047-COM0149	\$100
70-1047-COM0144			
70-1047-COM0145			
70-1047-COM0146			
70-1047-COM0147			
70-1047-COM0148			
70-1047-COM0149			
	Inclusive® 30° Multi-Unit Abutment 4 mmH* 4.1 mm	70-1047-COM0150	\$100
	Inclusive® 30° Multi-Unit Abutment 5 mmH* 4.1 mm	70-1047-COM0151	\$100
70-1047-COM0150			
70-1047-COM0151			
<i>(Angled Multi-Unit Abutments include Angled Abutment Screw. Prosthetic Screw sold separately; please see page 11.)</i>			

MULTI-UNIT TITANIUM SCREWS



Inclusive® Angled Multi-Unit Abutment Screw* 3.4/4.1/5.0/6.0 mm 70-1047-COM0152 \$12

MULTI-UNIT ABUTMENT ACCESSORIES

For a complete line of Multi-Unit Abutment Accessories, please see page 11.



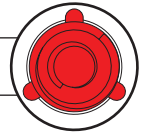

**compatible with: Biomet 3i™ Certain®*

Implant components compatible with: **CAMLOG® SCREW-LINE**



















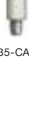

CAMLOG is a registered trademark of Camlog Biotechnologies AG.

IMPLANT ANALOGS

	Description (with Platform Size)	Code	Price
	Inclusive® Implant Analog (5-pack)* 3.3 mm	70-1135-CAM0068	\$60
	Inclusive® Implant Analog (5-pack)* 3.8 mm	70-1135-CAM0070	\$60
	Inclusive® Implant Analog (5-pack)* 4.3 mm	70-1135-CAM0072	\$60
	Inclusive® Implant Analog (5-pack)* 5.0 mm	70-1135-CAM0074	\$60
	Inclusive® Implant Analog (5-pack)* 6.0 mm	70-1135-CAM0076	\$60

SCANNING ABUTMENTS

	Description (with Platform Size)	Code	Price
Clinical Use (radiopaque)			
	Inclusive® Clinical Scanning Abutment, Anterior* 3.3 mm	70-1135-CAM0092	\$15
	Inclusive® Clinical Scanning Abutment, Anterior* 3.8 mm	70-1135-CAM0093	\$15
	Inclusive® Clinical Scanning Abutment, Anterior* 4.3 mm	70-1135-CAM0094	\$15
	Inclusive® Clinical Scanning Abutment, Anterior* 5.0 mm	70-1135-CAM0095	\$15
	Inclusive® Clinical Scanning Abutment, Anterior* 6.0 mm	70-1135-CAM0096	\$15
Clinical Use (radiopaque)			
	Inclusive® Clinical Scanning Abutment, Posterior* 3.3 mm	70-1135-CAM0182	\$15
	Inclusive® Clinical Scanning Abutment, Posterior* 3.8 mm	70-1135-CAM0183	\$15
	Inclusive® Clinical Scanning Abutment, Posterior* 4.3 mm	70-1135-CAM0184	\$15
	Inclusive® Clinical Scanning Abutment, Posterior* 5.0 mm	70-1135-CAM0185	\$15
	Inclusive® Clinical Scanning Abutment, Posterior* 6.0 mm	70-1135-CAM0186	\$15
Laboratory Packs (radiolucent)			
	Inclusive® Laboratory Scanning Abutment (3-pack)* 3.3 mm	70-1135-CAM0172	\$45
	Inclusive® Laboratory Scanning Abutment (3-pack)* 3.8 mm	70-1135-CAM0173	\$45
	Inclusive® Laboratory Scanning Abutment (3-pack)* 4.3 mm	70-1135-CAM0174	\$45
	Inclusive® Laboratory Scanning Abutment (3-pack)* 5.0 mm	70-1135-CAM0175	\$45
	Inclusive® Laboratory Scanning Abutment (3-pack)* 6.0 mm	70-1135-CAM0176	\$45
Blue Light Scanner Laboratory Packs (radiolucent)			
	Inclusive® Laboratory Scanning Abutment† (3-pack)* 3.3 mm	70-1135-CAM0197	\$45
	Inclusive® Laboratory Scanning Abutment† (3-pack)* 3.8 mm	70-1135-CAM0198	\$45
	Inclusive® Laboratory Scanning Abutment† (3-pack)* 4.3 mm	70-1135-CAM0199	\$45
	Inclusive® Laboratory Scanning Abutment† (3-pack)* 5.0 mm	70-1135-CAM0200	\$45
	Inclusive® Laboratory Scanning Abutment† (3-pack)* 6.0 mm	70-1135-CAM0201	\$45

†for Blue Light Scanners

(Scanning Abutments include Captured Screw.)





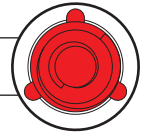





*compatible with: Camlog® Screw-Line

Implant components compatible with: CAMLOG® SCREW-LINE

















CAMLOG is a registered trademark of Camlog Biotechnologies AG.

BITE VERIFICATION CYLINDERS

Description (with Platform Size)	Code	Price
 Inclusive® Bite Verification Cylinder* 3.3 mm	70-1135-CAM0042	\$30
 Inclusive® Bite Verification Cylinder* 3.8 mm	70-1135-CAM0044	\$30
 Inclusive® Bite Verification Cylinder* 4.3 mm	70-1135-CAM0046	\$30
 Inclusive® Bite Verification Cylinder* 5.0 mm	70-1135-CAM0048	\$30
 Inclusive® Bite Verification Cylinder* 6.0 mm	70-1135-CAM0050	\$30
 Inclusive® Bite Verification Cylinder, Non-Engaging* 3.3 mm	70-1135-CAM0052	\$30
 Inclusive® Bite Verification Cylinder, Non-Engaging* 3.8 mm	70-1135-CAM0054	\$30
 Inclusive® Bite Verification Cylinder, Non-Engaging* 4.3 mm	70-1135-CAM0056	\$30
 Inclusive® Bite Verification Cylinder, Non-Engaging* 5.0 mm	70-1135-CAM0058	\$30
 Inclusive® Bite Verification Cylinder, Non-Engaging* 6.0 mm	70-1135-CAM0060	\$30

(Bite Verification Cylinders include Titanium Screw and Guide Pin.)

TITANIUM ABUTMENTS

 Inclusive® Titanium Abutment 4.5 mmH* 3.3 mm	70-1135-CAM0012	\$35
 Inclusive® Titanium Abutment 4.5 mmH* 3.8 mm	70-1135-CAM0014	\$35
 Inclusive® Titanium Abutment 4.5 mmH* 4.3 mm	70-1135-CAM0016	\$35
 Inclusive® Titanium Abutment 4.5 mmH* 5.0 mm	70-1135-CAM0018	\$35
 Inclusive® Titanium Abutment 4.5 mmH* 6.0 mm	70-1135-CAM0020	\$35
 Inclusive® Titanium Abutment 6 mmH* 3.3 mm	70-1135-CAM0032	\$35
 Inclusive® Titanium Abutment 6 mmH* 3.8 mm	70-1135-CAM0034	\$35
 Inclusive® Titanium Abutment 6 mmH* 4.3 mm	70-1135-CAM0036	\$35
 Inclusive® Titanium Abutment 6 mmH* 5.0 mm	70-1135-CAM0038	\$35
 Inclusive® Titanium Abutment 6 mmH* 6.0 mm	70-1135-CAM0040	\$35
 Inclusive® Titanium Abutment 4.5 mmH, Non-Engaging* 3.3 mm	70-1135-CAM0022	\$35
 Inclusive® Titanium Abutment 4.5 mmH, Non-Engaging* 3.8 mm	70-1135-CAM0024	\$35
 Inclusive® Titanium Abutment 4.5 mmH, Non-Engaging* 4.3 mm	70-1135-CAM0026	\$35
 Inclusive® Titanium Abutment 4.5 mmH, Non-Engaging* 5.0 mm	70-1135-CAM0028	\$35
 Inclusive® Titanium Abutment 4.5 mmH, Non-Engaging* 6.0 mm	70-1135-CAM0030	\$35

(Titanium Screw sold separately; please see page 18.)







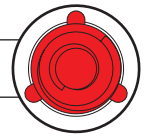

*compatible with: Camlog® Screw-Line

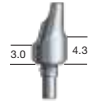
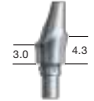
Implant components compatible with: CAMLOG® SCREW-LINE

CAMLOG is a registered trademark of Camlog Biotechnologies AG.







TITANIUM ESTHETIC ABUTMENTS



Description (with Platform Size)		Code	Price
	Inclusive® 15° Titanium Esthetic Abutment, Anterior* 3.3 mm	70-1135-CAM0148	\$85
	Inclusive® 15° Titanium Esthetic Abutment, Anterior* 3.8 mm	70-1135-CAM0149	\$85
	Inclusive® 15° Titanium Esthetic Abutment, Anterior* 4.3 mm	70-1135-CAM0150	\$85
	Inclusive® 15° Titanium Esthetic Abutment, Posterior* 4.3 mm	70-1135-CAM0151	\$85
	Inclusive® 15° Titanium Esthetic Abutment, Posterior* 5.0 mm	70-1135-CAM0152	\$85
	Inclusive® Titanium Esthetic Abutment, Anterior* 3.3 mm	70-1135-CAM0153	\$85
	Inclusive® Titanium Esthetic Abutment, Anterior* 3.8 mm	70-1135-CAM0154	\$85
	Inclusive® Titanium Esthetic Abutment, Anterior* 4.3 mm	70-1135-CAM0155	\$85
	Inclusive® Titanium Esthetic Abutment, Posterior* 4.3 mm	70-1135-CAM0156	\$85
	Inclusive® Titanium Esthetic Abutment, Posterior* 5.0 mm	70-1135-CAM0157	\$85

(Esthetic Abutments include Titanium Screw.)

TITANIUM ABUTMENT BLANKS



	Inclusive® Titanium Abutment Blank* 3.3 mm	70-1135-CAM0117	\$30
	Inclusive® Titanium Abutment Blank* 3.8 mm	70-1135-CAM0118	\$30
	Inclusive® Titanium Abutment Blank* 4.3 mm	70-1135-CAM0119	\$30
	Inclusive® Titanium Abutment Blank* 5.0 mm	70-1135-CAM0120	\$30
	Inclusive® Titanium Abutment Blank* 6.0 mm	70-1135-CAM0121	\$30

UCLA PLASTIC ABUTMENTS

	Inclusive® UCLA Plastic Abutment, Non-Engaging* 3.3 mm	70-1135-CAM0163	\$35
	Inclusive® UCLA Plastic Abutment, Non-Engaging* 3.8 mm	70-1135-CAM0164	\$35
	Inclusive® UCLA Plastic Abutment, Non-Engaging* 4.3 mm	70-1135-CAM0165	\$35
	Inclusive® UCLA Plastic Abutment, Non-Engaging* 5.0 mm	70-1135-CAM0166	\$35
	Inclusive® UCLA Plastic Abutment, Non-Engaging* 6.0 mm	70-1135-CAM0167	\$35

(UCLA Abutments include Titanium Screw and Guide Pin.)

TITANIUM SCREWS AND GUIDE PINS

	Inclusive® Titanium Screw* 3.3/3.8/4.3 mm	70-1135-CAM0124	\$12
	Inclusive® Titanium Screw (5-pack)* 3.3/3.8/4.3 mm	70-1135-CAM0125	\$50
	Inclusive® Titanium Screw* 5.0/6.0 mm	70-1135-CAM0126	\$12
	Inclusive® Titanium Screw (5-pack)* 5.0/6.0 mm	70-1135-CAM0127	\$50

*compatible with: Camlog® Screw-Line

Implant components compatible with: **CAMLOG® SCREW-LINE**

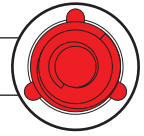

CAMLOG is a registered trademark of Camlog Biotechnologies AG.

TITANIUM SCREWS AND GUIDE PINS



Description	Code	Price
Inclusive® Guide Pin (5-pack)* 3.3/3.8/4.3 mm	70-1135-CAM0064	\$50
Inclusive® Guide Pin (5-pack)* 5.0/6.0 mm	70-1135-CAM0066	\$50

MULTI-UNIT ABUTMENTS



Inclusive® Multi-Unit Abutment 1 mmH* 3.8 mm	70-1135-CAM0128	\$100
Inclusive® Multi-Unit Abutment 2 mmH* 3.8 mm	70-1135-CAM0129	\$100
Inclusive® Multi-Unit Abutment 3 mmH* 3.8 mm	70-1135-CAM0130	\$100
Inclusive® Multi-Unit Abutment 1 mmH* 4.3 mm	70-1135-CAM0131	\$100
Inclusive® Multi-Unit Abutment 2 mmH* 4.3 mm	70-1135-CAM0132	\$100
Inclusive® Multi-Unit Abutment 3 mmH* 4.3 mm	70-1135-CAM0133	\$100
Inclusive® Multi-Unit Abutment 5 mmH* 4.3 mm	70-1135-CAM0134	\$100
Inclusive® Multi-Unit Abutment 1 mmH* 5.0 mm	70-1135-CAM0135	\$100
Inclusive® Multi-Unit Abutment 2 mmH* 5.0 mm	70-1135-CAM0136	\$100
Inclusive® Multi-Unit Abutment 3 mmH* 5.0 mm	70-1135-CAM0137	\$100

(Prosthetic Screw sold separately; please see page 11.)

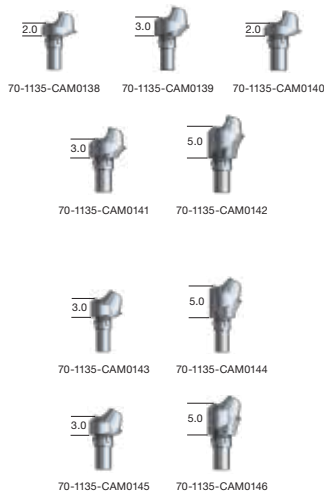

Inclusive® 17° Multi-Unit Abutment 2 mmH* 3.8 mm	70-1135-CAM0138	\$100
Inclusive® 17° Multi-Unit Abutment 3 mmH* 3.8 mm	70-1135-CAM0139	\$100
Inclusive® 17° Multi-Unit Abutment 2 mmH* 4.3 mm	70-1135-CAM0140	\$100
Inclusive® 17° Multi-Unit Abutment 3 mmH* 4.3 mm	70-1135-CAM0141	\$100
Inclusive® 17° Multi-Unit Abutment 5 mmH* 4.3 mm	70-1135-CAM0142	\$100

Inclusive® 30° Multi-Unit Abutment 3 mmH* 3.8 mm	70-1135-CAM0143	\$100
Inclusive® 30° Multi-Unit Abutment 5 mmH* 3.8 mm	70-1135-CAM0144	\$100
Inclusive® 30° Multi-Unit Abutment 3 mmH* 4.3 mm	70-1135-CAM0145	\$100
Inclusive® 30° Multi-Unit Abutment 5 mmH* 4.3 mm	70-1135-CAM0146	\$100

(Angled Multi-Unit Abutments include Angled Abutment Screw. Prosthetic Screw sold separately; please see page 11.)

MULTI-UNIT TITANIUM SCREWS



Inclusive® Angled Multi-Unit Abutment Screw* 3.8/4.3 mm	70-1135-CAM0147	\$12
---	-----------------	------

MULTI-UNIT ABUTMENT ACCESSORIES

For a complete line of Multi-Unit Abutment Accessories, please see page 11.

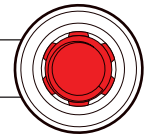

**compatible with: Camlog® Screw-Line*

Implant components compatible with: Dentsply Implants Ankylos® C/X







ANKYLOS is a registered trademark of DeguDent GMBH LLC.



IMPLANT ANALOGS

	Description (with Platform Size)	Code	Price
 70-1139-COM0020	Inclusive® Implant Analog (5-pack)* C/X 3.5 A	70-1139-COM0020	\$60
 70-1139-COM0021	Inclusive® Implant Analog (5-pack)* C/X 4.5 B	70-1139-COM0021	\$60
 70-1139-COM0022	Inclusive® Implant Analog (5-pack)* C/X 5.5 C	70-1139-COM0022	\$60





SCANNING ABUTMENTS

 70-1139-COM0040	Clinical Use (radiopaque) Inclusive® Clinical Scanning Abutment, Anterior* /X	70-1139-COM0040	\$15
 70-1139-COM0039	Inclusive® Clinical Scanning Abutment, Posterior* /X	70-1139-COM0039	\$15
 70-1139-COM0038	Laboratory Packs (radiolucent) Inclusive® Laboratory Scanning Abutment (3-pack)* /X	70-1139-COM0038	\$45
 70-1139-COM0056	Blue Light Scanner Laboratory Packs (radiolucent) Inclusive® Laboratory Scanning Abutment† (3-pack)* /X <i>†for Blue Light Scanners</i> <i>(Scanning Abutments include Captured Screw.)</i>	70-1139-COM0056	\$45

BITE VERIFICATION CYLINDERS

 70-1139-COM0048	Inclusive® Bite Verification Cylinder, Non-Engaging* C/	70-1139-COM0048	\$30
 70-1139-COM0049	Inclusive® Bite Verification Cylinder* /X <i>(Bite Verification Cylinders include Titanium Screw and Guide Pin.)</i>	70-1139-COM0049	\$30

TITANIUM ABUTMENTS

 70-1139-COM0041	Inclusive® Titanium Abutment 4.5 mmH, Non-Engaging* C/ 3.5 A	70-1139-COM0041	\$35
 70-1139-COM0042	Inclusive® Titanium Abutment 4.5 mmH, Non-Engaging* C/ 4.5 B	70-1139-COM0042	\$35
 70-1139-COM0043	Inclusive® Titanium Abutment 4.5 mmH, Non-Engaging* C/ 5.5 C	70-1139-COM0043	\$35
 70-1139-COM0045	Inclusive® Titanium Abutment 4.5 mmH* /X 3.5 A	70-1139-COM0045	\$35
 70-1139-COM0046	Inclusive® Titanium Abutment 6 mmH* /X 3.5 A <i>(Titanium Screw sold separately; please see page 21.)</i>	70-1139-COM0046	\$35



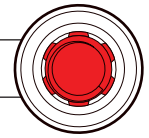

*compatible with: Dentsply Implants Ankylos®

Implant components compatible with: Dentsply Implants Ankylos® C/X



ANKYLOS is a registered trademark of DeguDent GMBH LLC.

TITANIUM ESTHETIC ABUTMENTS

Description (with Platform Size)		Code	Price
	Inclusive® Titanium Esthetic Abutment, Anterior* /X	70-1139-COM0050	\$85
	Inclusive® Titanium Esthetic Abutment, Posterior* /X	70-1139-COM0051	\$85
	Inclusive® 15° Titanium Esthetic Abutment, Anterior* /X	70-1139-COM0052	\$85
	Inclusive® 15° Titanium Esthetic Abutment, Posterior* /X	70-1139-COM0053	\$85



(Esthetic Abutments include Titanium Screw.)

UCLA PLASTIC ABUTMENTS

	Inclusive® UCLA Plastic Abutment, Non-Engaging* C/ <i>(UCLA Abutments include Titanium Screw and Guide Pin.)</i>	70-1139-COM0047	\$35
---	---	-----------------	------





70-1139-COM0047

TITANIUM SCREWS AND GUIDE PINS

	Inclusive® Guide Pin (5-pack)* C/X	70-1139-COM0057	\$50
	Inclusive® Titanium Screw* C/X	70-1139-COM0014	\$12
	Inclusive® Titanium Screw (5-pack)* C/X	70-1139-COM0019	\$50

70-1139-COM0057 70-1139-COM0014
70-1139-COM0019

MULTI-UNIT ABUTMENTS

	Inclusive® Multi-Unit Abutment 1.5 mmH* /X	70-1139-COM0001	\$100
	Inclusive® Multi-Unit Abutment 2.5 mmH* /X	70-1139-COM0002	\$100
	Inclusive® Multi-Unit Abutment 3.5 mmH* /X	70-1139-COM0003	\$100
	Inclusive® Multi-Unit Abutment 4.5 mmH* /X	70-1139-COM0004	\$100

(Prosthetic Screw sold separately; please see page 11.)

70-1139-COM0003 70-1139-COM0004



MULTI-UNIT ABUTMENT ACCESSORIES

For a complete line of Multi-Unit Abutment Accessories, please see page 11.

*compatible with: Dentsply Implants Ankylos®





IMPLANT ANALOGS



Description (with Platform Size)			Code	Price	
			Inclusive® Implant Analog (5-pack)* 3.0	70-1048-COM0014	\$60
			Inclusive® Implant Analog (5-pack)* 3.5/4.0	70-1048-COM0016	\$60
			Inclusive® Implant Analog (5-pack)* 4.5/5.0	70-1048-COM0019	\$60

SCANNING ABUTMENTS



Clinical Use (radiopaque)

			Inclusive® Clinical Scanning Abutment, Anterior* 3.0	70-1048-COM0124	\$15
			Inclusive® Clinical Scanning Abutment, Anterior* 3.5/4.0	70-1048-COM0125	\$15
			Inclusive® Clinical Scanning Abutment, Anterior* 4.5/5.0	70-1048-COM0126	\$15



Clinical Use (radiopaque)

			Inclusive® Clinical Scanning Abutment, Posterior* 3.0	70-1048-COM0179	\$15
			Inclusive® Clinical Scanning Abutment, Posterior* 3.5/4.0	70-1048-COM0180	\$15
			Inclusive® Clinical Scanning Abutment, Posterior* 4.5/5.0	70-1048-COM0181	\$15

Laboratory Packs (radiolucent)

			Inclusive® Laboratory Scanning Abutment (3-pack)* 3.0	70-1048-COM0173	\$45
			Inclusive® Laboratory Scanning Abutment (3-pack)* 3.5/4.0	70-1048-COM0174	\$45
			Inclusive® Laboratory Scanning Abutment (3-pack)* 4.5/5.0	70-1048-COM0175	\$45





Blue Light Scanner Laboratory Packs (radiolucent)

			Inclusive® Laboratory Scanning Abutment† (3-pack)* 3.0	70-1048-COM0188	\$45
			Inclusive® Laboratory Scanning Abutment† (3-pack)* 3.5/4.0	70-1048-COM0189	\$45
			Inclusive® Laboratory Scanning Abutment† (3-pack)* 4.5/5.0	70-1048-COM0190	\$45

†for Blue Light Scanners

(Scanning Abutments include Captured Screw.)

BITE VERIFICATION CYLINDERS









			Inclusive® Bite Verification Cylinder* 3.0	70-1048-COM0133	\$30
			Inclusive® Bite Verification Cylinder* 3.5/4.0	70-1048-COM0134	\$30
			Inclusive® Bite Verification Cylinder* 4.5/5.0	70-1048-COM0135	\$30
			Inclusive® Bite Verification Cylinder, Non-Engaging* 3.5/4.0	70-1048-COM0131	\$30
			Inclusive® Bite Verification Cylinder, Non-Engaging* 4.5/5.0	70-1048-COM0132	\$30

(Bite Verification Cylinders include Titanium Screw and Guide Pin.)

*compatible with: Dentsply Implants Astra Tech Implant System®













TITANIUM ABUTMENTS

	Description (with Platform Size)	Code	Price
	Inclusive® Titanium Abutment 4.5 mmH* 3.0	70-1048-COM0089	\$35
	Inclusive® Titanium Abutment 4.5 mmH* 3.5/4.0	70-1048-COM0091	\$35
	Inclusive® Titanium Abutment 4.5 mmH* 4.5/5.0	70-1048-COM0093	\$35
70-1048-COM0089			
70-1048-COM0091			
70-1048-COM0093			
	Inclusive® Titanium Abutment 6 mmH* 3.0	70-1048-COM0004	\$35
	Inclusive® Titanium Abutment 6 mmH* 3.5/4.0	70-1048-COM0005	\$35
	Inclusive® Titanium Abutment 6 mmH* 4.5/5.0	70-1048-COM0006	\$35
70-1048-COM0004			
70-1048-COM0005			
70-1048-COM0006			
	Inclusive® Titanium Abutment 4.5 mmH, Non-Engaging* 3.5/4.0	70-1048-COM0097	\$35
	Inclusive® Titanium Abutment 4.5 mmH, Non-Engaging* 4.5/5.0	70-1048-COM0099	\$35
70-1048-COM0097			
70-1048-COM0099			



(Titanium Screw sold separately; please see page 24.)

TITANIUM ESTHETIC ABUTMENTS

	Inclusive® 15° Titanium Esthetic Abutment, Anterior* 3.0	70-1048-COM0153	\$85
	Inclusive® 15° Titanium Esthetic Abutment, Anterior* 3.5/4.0	70-1048-COM0154	\$85
	Inclusive® 15° Titanium Esthetic Abutment, Anterior* 4.5/5.0	70-1048-COM0155	\$85
70-1048-COM0153			
70-1048-COM0154			
70-1048-COM0155			
	Inclusive® 15° Titanium Esthetic Abutment, Posterior* 3.5/4.0	70-1048-COM0156	\$85
	Inclusive® 15° Titanium Esthetic Abutment, Posterior* 4.5/5.0	70-1048-COM0157	\$85
70-1048-COM0156			
70-1048-COM0157			
	Inclusive® Titanium Esthetic Abutment, Anterior* 3.0	70-1048-COM0158	\$85
	Inclusive® Titanium Esthetic Abutment, Anterior* 3.5/4.0	70-1048-COM0159	\$85
	Inclusive® Titanium Esthetic Abutment, Anterior* 4.5/5.0	70-1048-COM0160	\$85
70-1048-COM0158			
70-1048-COM0159			
70-1048-COM0160			
	Inclusive® Titanium Esthetic Abutment, Posterior* 3.5/4.0	70-1048-COM0161	\$85
	Inclusive® Titanium Esthetic Abutment, Posterior* 4.5/5.0	70-1048-COM0162	\$85
70-1048-COM0161			
70-1048-COM0162			

(Esthetic Abutments include Titanium Screw.)

TITANIUM ABUTMENT BLANKS

	Inclusive® Titanium Abutment Blank* 3.0	70-1048-COM0064	\$30
	Inclusive® Titanium Abutment Blank* 3.5/4.0	70-1048-COM0065	\$30
	Inclusive® Titanium Abutment Blank* 4.5/5.0	70-1048-COM0066	\$30
70-1048-COM0064			
70-1048-COM0065			
70-1048-COM0066			

*compatible with: Dentsply Implants Astra Tech Implant System®









UCLA PLASTIC ABUTMENTS







Description (with Platform Size)			Code	Price	
			Inclusive® UCLA Plastic Abutment* 3.0	70-1048-COM0163	\$35
			Inclusive® UCLA Plastic Abutment* 3.5/4.0	70-1048-COM0164	\$35
			Inclusive® UCLA Plastic Abutment* 4.5/5.0	70-1048-COM0165	\$35
			Inclusive® UCLA Plastic Abutment, Non-Engaging* 3.0	70-1048-COM0166	\$35
			Inclusive® UCLA Plastic Abutment, Non-Engaging* 3.5/4.0	70-1048-COM0167	\$35
			Inclusive® UCLA Plastic Abutment, Non-Engaging* 4.5/5.0	70-1048-COM0168	\$35

(UCLA Abutments include Titanium Screw and Guide Pin.)

TITANIUM SCREWS AND GUIDE PINS

			Inclusive® Titanium Screw* 3.0	70-1048-COM0121	\$12
			Inclusive® Titanium Screw (5-pack)* 3.0	70-1048-COM0031	\$50
			Inclusive® Titanium Screw* 3.5/4.0	70-1048-COM0122	\$12
			Inclusive® Titanium Screw (5-pack)* 3.5/4.0	70-1048-COM0033	\$50
			Inclusive® Titanium Screw* 4.5/5.0	70-1048-COM0123	\$12
			Inclusive® Titanium Screw (5-pack)* 4.5/5.0	70-1048-COM0036	\$50
			Inclusive® Guide Pin (5-pack)* 3.0	70-1048-COM0110	\$50
			Inclusive® Guide Pin (5-pack)* 3.5/4.0	70-1048-COM0112	\$50
			Inclusive® Guide Pin (5-pack)* 4.5/5.0	70-1048-COM0114	\$50

MULTI-UNIT ABUTMENTS



			Inclusive® Multi-Unit Abutment 1.5 mmH* 3.5/4.0	70-1048-COM0136	\$100
			Inclusive® Multi-Unit Abutment 2.5 mmH* 3.5/4.0	70-1048-COM0137	\$100
			Inclusive® Multi-Unit Abutment 3.5 mmH* 3.5/4.0	70-1048-COM0138	\$100
			Inclusive® Multi-Unit Abutment 1.5 mmH* 4.5/5.0	70-1048-COM0139	\$100
			Inclusive® Multi-Unit Abutment 2.5 mmH* 4.5/5.0	70-1048-COM0140	\$100
			Inclusive® Multi-Unit Abutment 3.5 mmH* 4.5/5.0	70-1048-COM0141	\$100
			Inclusive® Multi-Unit Abutment 4.5 mmH* 4.5/5.0	70-1048-COM0142	\$100

(Prosthetic Screw sold separately; please see page 11.)

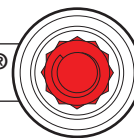
*compatible with: Dentsply Implants Astra Tech Implant System®





MULTI-UNIT ABUTMENTS

Description (with Platform Size)		Code	Price	
		Inclusive® 17° Multi-Unit Abutment 2.5 mmH* 3.5/4.0	70-1048-COM0143	\$100
70-1048-COM0143	70-1048-COM0144	Inclusive® 17° Multi-Unit Abutment 3.5 mmH* 3.5/4.0	70-1048-COM0144	\$100
		Inclusive® 17° Multi-Unit Abutment 2.5 mmH* 4.5/5.0	70-1048-COM0145	\$100
70-1048-COM0145	70-1048-COM0146	Inclusive® 17° Multi-Unit Abutment 3.5 mmH* 4.5/5.0	70-1048-COM0146	\$100
		Inclusive® 30° Multi-Unit Abutment 3.5 mmH* 3.5/4.0	70-1048-COM0147	\$100
70-1048-COM0147	70-1048-COM0148	Inclusive® 30° Multi-Unit Abutment 4.5 mmH* 3.5/4.0	70-1048-COM0148	\$100
		Inclusive® 30° Multi-Unit Abutment 3.5 mmH* 4.5/5.0	70-1048-COM0149	\$100
70-1048-COM0149	70-1048-COM0150	Inclusive® 30° Multi-Unit Abutment 4.5 mmH* 4.5/5.0	70-1048-COM0150	\$100

(Angled Multi-Unit Abutments include Angled Abutment Screw. Prosthetic Screw sold separately; please see page 11.)

MULTI-UNIT TITANIUM SCREWS

	Inclusive® Angled Multi-Unit Abutment Screw* 3.5/4.0	70-1048-COM0151	\$12
70-1048-COM0151			
	Inclusive® Angled Multi-Unit Abutment Screw* 4.5/5.0	70-1048-COM0152	\$12
70-1048-COM0152			

MULTI-UNIT ABUTMENT ACCESSORIES

For a complete line of Multi-Unit Abutment Accessories, please see page 11.



*compatible with: Dentsply Implants Astra Tech Implant System®

Implant components compatible with: Hiossen® HG System

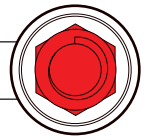







HIOSSSEN is a registered trademark of OSSTEM IMPLANT CO., LTD.



IMPLANT ANALOGS





Description (with Platform Size)		Code	Price
	Inclusive® Implant Analog (5-pack)* Mini	70-1147-COM0016	\$60
	Inclusive® Implant Analog (5-pack)* Standard	70-1147-COM0017	\$60

SCANNING ABUTMENTS

	Clinical Use (radiopaque) Inclusive® Clinical Scanning Abutment, Anterior* Standard	70-1147-COM0038	\$15
	Inclusive® Clinical Scanning Abutment, Anterior* Mini	70-1147-COM0039	\$15
	Clinical Use (radiopaque) Inclusive® Clinical Scanning Abutment, Posterior* Standard	70-1147-COM0040	\$15
	Inclusive® Clinical Scanning Abutment, Posterior* Mini	70-1147-COM0041	\$15
	Laboratory Packs (radiolucent) Inclusive® Laboratory Scanning Abutment (3-pack)* Standard	70-1147-COM0022	\$45
	Inclusive® Laboratory Scanning Abutment (3-pack)* Mini	70-1147-COM0023	\$45
	Blue Light Scanner Laboratory Packs (radiolucent) Inclusive® Laboratory Scanning Abutment† (3-pack)* Standard	70-1147-COM0024	\$45
	Inclusive® Laboratory Scanning Abutment† (3-pack)* Mini	70-1147-COM0025	\$45





†for Blue Light Scanners
(Scanning Abutments include Captured Screw.)

BITE VERIFICATION CYLINDERS

	Inclusive® Bite Verification Cylinder* Standard	70-1147-COM0062	\$30
	Inclusive® Bite Verification Cylinder* Mini	70-1147-COM0063	\$30
	Inclusive® Bite Verification Cylinder, Non-Engaging* Standard	70-1147-COM0060	\$30
	Inclusive® Bite Verification Cylinder, Non-Engaging* Mini	70-1147-COM0061	\$30

(Bite Verification Cylinders include Titanium Screw and Guide Pin.)

TITANIUM ABUTMENTS

	Inclusive® Titanium Abutment 4.5 mmH* Standard	70-1147-COM0042	\$35
	Inclusive® Titanium Abutment 4.5 mmH* Mini	70-1147-COM0043	\$35
	Inclusive® Titanium Abutment 4.5 mmH, Non-Engaging* Standard	70-1147-COM0044	\$35
	Inclusive® Titanium Abutment 4.5 mmH, Non-Engaging* Mini	70-1147-COM0045	\$35



*compatible with: Hiossen® HG System

Implant components compatible with: **Hiossen® HG System**

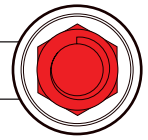







HIOSSSEN is a registered trademark of OSSTEM IMPLANT CO., LTD.







TITANIUM ABUTMENTS

Description (with Platform Size)		Code	Price
	Inclusive® Titanium Abutment 6 mmH* Standard	70-1147-COM0046	\$35
	Inclusive® Titanium Abutment 6 mmH* Mini	70-1147-COM0047	\$35
<i>(Titanium Screw sold separately; please see page 27.)</i>			







TITANIUM ESTHETIC ABUTMENTS

	Inclusive® 15° Titanium Esthetic Abutment, Anterior* Standard	70-1147-COM0052	\$85
	Inclusive® 15° Titanium Esthetic Abutment, Anterior* Mini	70-1147-COM0053	\$85
	Inclusive® 15° Titanium Esthetic Abutment, Posterior* Standard	70-1147-COM0054	\$85
	Inclusive® 15° Titanium Esthetic Abutment, Posterior* Mini	70-1147-COM0055	\$85
	Inclusive® Titanium Esthetic Abutment, Anterior* Standard	70-1147-COM0048	\$85
	Inclusive® Titanium Esthetic Abutment, Anterior* Mini	70-1147-COM0049	\$85
	Inclusive® Titanium Esthetic Abutment, Posterior* Standard	70-1147-COM0050	\$85
	Inclusive® Titanium Esthetic Abutment, Posterior* Mini	70-1147-COM0051	\$85
<i>(Esthetic Abutments include Titanium Screw.)</i>			

UCLA PLASTIC ABUTMENTS

	Inclusive® UCLA Plastic Abutment* Standard	70-1147-COM0058	\$35
	Inclusive® UCLA Plastic Abutment* Mini	70-1147-COM0059	\$35
	Inclusive® UCLA Plastic Abutment, Non-Engaging* Standard	70-1147-COM0056	\$35
	Inclusive® UCLA Plastic Abutment, Non-Engaging* Mini	70-1147-COM0057	\$35
<i>(UCLA Abutments include Titanium Screw and Guide Pin.)</i>			

TITANIUM SCREWS AND GUIDE PINS

	Inclusive® Titanium Screw* Standard	70-1147-COM0011	\$12
	Inclusive® Titanium Screw* Mini	70-1147-COM0010	\$12
	Inclusive® Titanium Screw (5-pack)* Standard	70-1147-COM0015	\$50
	Inclusive® Titanium Screw (5-pack)* Mini	70-1147-COM0014	\$50
	Inclusive® Guide Pin (5-pack)* Standard	70-1147-COM0083	\$50
	Inclusive® Guide Pin (5-pack)* Mini	70-1147-COM0084	\$50

**compatible with: Hiossen® HG System*

Implant components compatible with: Hiossen® HG System

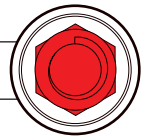

HIOSSSEN is a registered trademark of OSSTEM IMPLANT CO., LTD.



MULTI-UNIT ABUTMENTS

Description (with Platform Size)		Code	Price	
		Inclusive® Multi-Unit Abutment 1.5 mmH* Standard Inclusive® Multi-Unit Abutment 1.5 mmH* Mini	70-1147-COM0064 70-1147-COM0065	\$100 \$100
		Inclusive® Multi-Unit Abutment 2.5 mmH* Standard Inclusive® Multi-Unit Abutment 2.5 mmH* Mini	70-1147-COM0066 70-1147-COM0067	\$100 \$100
		Inclusive® Multi-Unit Abutment 3.5 mmH* Standard Inclusive® Multi-Unit Abutment 3.5 mmH* Mini	70-1147-COM0068 70-1147-COM0069	\$100 \$100
		Inclusive® Multi-Unit Abutment 4.5 mmH* Standard <i>(Prosthetic Screw sold separately; please see page 11.)</i>	70-1147-COM0070	\$100
		Inclusive® 17° Multi-Unit Abutment 2.5 mmH* Standard Inclusive® 17° Multi-Unit Abutment 2.5 mmH* Mini	70-1147-COM0071 70-1147-COM0072	\$100 \$100
		Inclusive® 17° Multi-Unit Abutment 3.5 mmH* Standard Inclusive® 17° Multi-Unit Abutment 3.5 mmH* Mini	70-1147-COM0073 70-1147-COM0074	\$100 \$100
		Inclusive® 30° Multi-Unit Abutment 3.5 mmH* Standard Inclusive® 30° Multi-Unit Abutment 3.5 mmH* Mini	70-1147-COM0075 70-1147-COM0076	\$100 \$100
		Inclusive® 30° Multi-Unit Abutment 4.5 mmH* Standard Inclusive® 30° Multi-Unit Abutment 4.5 mmH* Mini	70-1147-COM0077 70-1147-COM0078	\$100 \$100

MULTI-UNIT TITANIUM SCREWS







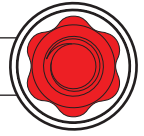





	Inclusive® Angled Multi-Unit Abutment Screw* Standard	70-1147-COM0079	\$12
	Inclusive® Angled Multi-Unit Abutment Screw* Mini	70-1147-COM0080	\$12

MULTI-UNIT ABUTMENT ACCESSORIES

For a complete line of Multi-Unit Abutment Accessories, please see page 11.



SCANNING ABUTMENTS

Description (with Platform Size)			Code	Price	
Clinical Use (radiopaque)					
			Inclusive® Clinical Scanning Abutment, Anterior* SD	70-1055-COM0017	\$15
			Inclusive® Clinical Scanning Abutment, Anterior* RD	70-1055-COM0018	\$15
			Inclusive® Clinical Scanning Abutment, Anterior* WD	70-1055-COM0019	\$15
70-1055-COM0017	70-1055-COM0018	70-1055-COM0019			
Clinical Use (radiopaque)					
			Inclusive® Clinical Scanning Abutment, Posterior* SD	70-1055-COM0035	\$15
			Inclusive® Clinical Scanning Abutment, Posterior* RD	70-1055-COM0036	\$15
			Inclusive® Clinical Scanning Abutment, Posterior* WD	70-1055-COM0037	\$15
70-1055-COM0035	70-1055-COM0036	70-1055-COM0037			
Laboratory Packs (radiolucent)					
			Inclusive® Laboratory Scanning Abutment (3-pack)* SD	70-1055-COM0029	\$45
			Inclusive® Laboratory Scanning Abutment (3-pack)* RD	70-1055-COM0030	\$45
			Inclusive® Laboratory Scanning Abutment (3-pack)* WD	70-1055-COM0031	\$45
70-1055-COM0029	70-1055-COM0030	70-1055-COM0031			
Blue Light Scanner Laboratory Packs (radiolucent)					
			Inclusive® Laboratory Scanning Abutment† (3-pack)* SD	70-1055-COM0044	\$45
			Inclusive® Laboratory Scanning Abutment† (3-pack)* RD	70-1055-COM0045	\$45
			Inclusive® Laboratory Scanning Abutment† (3-pack)* WD	70-1055-COM0046	\$45
70-1055-COM0044	70-1055-COM0045	70-1055-COM0046			
†for Blue Light Scanners					
(Scanning Abutments include Captured Screw.)					

*compatible with: Keystone Dental PrimaConnex®

Implant components compatible with: MegaGen AnyRidge®

ANYRIDGE is a registered trademark of MEGAGEN IMPLANT CO., LTD.

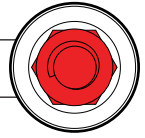

IMPLANT ANALOGS



Description (with Platform Size)	Code	Price
Inclusive® Implant Analog (5-pack)*	70-1173-COM0002	\$60

SCANNING ABUTMENTS



Clinical Use (radiopaque)		
Inclusive® Clinical Scanning Abutment, Anterior*	70-1173-COM0009	\$15
Inclusive® Clinical Scanning Abutment, Posterior*	70-1173-COM0008	\$15



Laboratory Packs (radiolucent)		
Inclusive® Laboratory Scanning Abutment (3-pack)*	70-1173-COM0006	\$45



Blue Light Scanner Laboratory Packs (radiolucent)		
Inclusive® Laboratory Scanning Abutment† (3-pack)*	70-1173-COM0007	\$45
†for Blue Light Scanners		
(Scanning Abutments include Captured Screw.)		

BITE VERIFICATION CYLINDERS

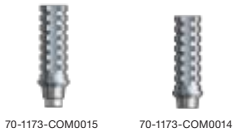

Inclusive® Bite Verification Cylinder*	70-1173-COM0015	\$30
Inclusive® Bite Verification Cylinder, Non-Engaging*	70-1173-COM0014	\$30
(Bite Verification Cylinders include Titanium Screw and Guide Pin.)		

TITANIUM ABUTMENTS



Inclusive® Titanium Abutment 4.5 mmH*	70-1173-COM0012	\$35
Inclusive® Titanium Abutment 6 mmH*	70-1173-COM0013	\$35



Inclusive® Titanium Abutment 4.5 mmH, Non-Engaging* Ø3.5	70-1173-COM0010	\$35
Inclusive® Titanium Abutment 4.5 mmH, Non-Engaging* Ø5.0	70-1173-COM0011	\$35
(Titanium Screw sold separately; please see page 31.)		

TITANIUM ESTHETIC ABUTMENTS

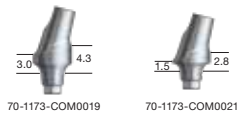

Inclusive® 15° Titanium Esthetic Abutment, Anterior*	70-1173-COM0019	\$85
Inclusive® 15° Titanium Esthetic Abutment, Posterior*	70-1173-COM0021	\$85

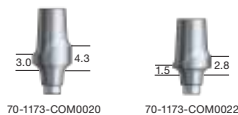

Inclusive® Titanium Esthetic Abutment, Anterior*	70-1173-COM0020	\$85
Inclusive® Titanium Esthetic Abutment, Posterior*	70-1173-COM0022	\$85
(Esthetic Abutments include Titanium Screw.)		



*compatible with: MegaGen AnyRidge® Implant System

Implant components compatible with: MegaGen AnyRidge®

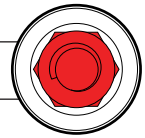

ANYRIDGE is a registered trademark of MEGAGEN IMPLANT CO., LTD.













UCLA PLASTIC ABUTMENTS

Description (with Platform Size)		Code	Price
	Inclusive® UCLA Plastic Abutment*	70-1173-COM0017	\$35
	Inclusive® UCLA Plastic Abutment, Non-Engaging*	70-1173-COM0016	\$35
<i>(UCLA Abutments include Titanium Screw and Guide Pin.)</i>			

TITANIUM SCREWS AND GUIDE PINS

	Inclusive® Titanium Screw*	70-1173-COM0004	\$12
	Inclusive® Titanium Screw (5-pack)*	70-1173-COM0001	\$50
	Inclusive® Guide Pin (5-pack)*	70-1173-COM0018	\$50

MULTI-UNIT ABUTMENTS

	Inclusive® Multi-Unit Abutment 2 mmH*	70-1173-COM0023	\$100
	Inclusive® Multi-Unit Abutment 3 mmH*	70-1173-COM0024	\$100
	Inclusive® Multi-Unit Abutment 4 mmH*	70-1173-COM0025	\$100
	Inclusive® Multi-Unit Abutment 5 mmH*	70-1173-COM0026	\$100
<i>(Prosthetic Screw sold separately; please see page 11.)</i>			
	Inclusive® 17° Multi-Unit Abutment 3.5 mmH*	70-1173-COM0027	\$100
	Inclusive® 17° Multi-Unit Abutment 4.5 mmH*	70-1173-COM0028	\$100
	Inclusive® 17° Multi-Unit Abutment 5.5 mmH*	70-1173-COM0029	\$100
	Inclusive® 30° Multi-Unit Abutment 3.5 mmH*	70-1173-COM0030	\$100
	Inclusive® 30° Multi-Unit Abutment 4.5 mmH*	70-1173-COM0031	\$100
	Inclusive® 30° Multi-Unit Abutment 5.5 mmH*	70-1173-COM0032	\$100
	Inclusive® 30° Multi-Unit Abutment 6.5 mmH*	70-1173-COM0033	\$100
<i>(Angled Multi-Unit Abutments include Angled Abutment Screw. Prosthetic Screw sold separately; please see page 11.)</i>			

MULTI-UNIT TITANIUM SCREWS

	Inclusive® Angled Multi-Unit Abutment Screw*	70-1173-COM0034	\$12
---	--	-----------------	------

MULTI-UNIT ABUTMENT ACCESSORIES

For a complete line of Multi-Unit Abutment Accessories, please see page 11.



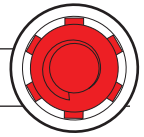

*compatible with: MegaGen AnyRidge® Implant System

Implant components compatible with: Neoss® Implant System



Neoss is a registered trademark of Neoss Limited.

SCANNING ABUTMENTS

Description (with Platform Size)	Code	Price
 70-1056-COM0006	<p>Clinical Use (radiopaque) Inclusive® Clinical Scanning Abutment, Anterior* 4.0 mm</p>	<p>70-1056-COM0006 \$15</p>
 70-1056-COM0012	<p>Clinical Use (radiopaque) Inclusive® Clinical Scanning Abutment, Posterior* 4.0 mm</p>	<p>70-1056-COM0012 \$15</p>
 70-1056-COM0010	<p>Laboratory Packs (radiolucent) Inclusive® Laboratory Scanning Abutment (3-pack)* 4.0 mm</p>	<p>70-1056-COM0010 \$45</p>
 70-1056-COM0015	<p>Blue Light Scanner Laboratory Packs (radiolucent) Inclusive® Laboratory Scanning Abutment† (3-pack)* 4.0 mm <i>†for Blue Light Scanners</i> (Scanning Abutments include Captured Screw.)</p>	<p>70-1056-COM0015 \$45</p>

*compatible with: Neoss® Implant System

Implant components compatible with: Nobel Biocare Brånemark System®

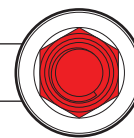





Brånemark System and Unigrip are trademarks of the Nobel Biocare group.



IMPLANT ANALOGS

	Description (with Platform Size)	Code	Price
 70-1049-COM0006	Inclusive® Implant Analog (5-pack)* RP	70-1049-COM0006	\$60



SCANNING ABUTMENTS

 70-1049-COM0041	<i>Clinical Use (radiopaque)</i> Inclusive® Clinical Scanning Abutment, Anterior* RP	70-1049-COM0041	\$15
 70-1049-COM0067	<i>Clinical Use (radiopaque)</i> Inclusive® Clinical Scanning Abutment, Posterior* RP	70-1049-COM0067	\$15
 70-1049-COM0065	<i>Laboratory Packs (radiolucent)</i> Inclusive® Laboratory Scanning Abutment (3-pack)* RP	70-1049-COM0065	\$45
 70-1049-COM0072	<i>Blue Light Scanner Laboratory Packs (radiolucent)</i> Inclusive® Laboratory Scanning Abutment† (3-pack)* RP <i>†for Blue Light Scanners</i> <i>(Scanning Abutments include Captured Screw.)</i>	70-1049-COM0072	\$45

BITE VERIFICATION CYLINDERS

 70-1049-COM0047	Inclusive® Bite Verification Cylinder* RP	70-1049-COM0047	\$30
 70-1049-COM0044	Inclusive® Bite Verification Cylinder, Non-Engaging* RP <i>(Bite Verification Cylinders include Titanium Screw Unigrip™ and Guide Pin Unigrip™.)</i>	70-1049-COM0044	\$30

TITANIUM ABUTMENTS

 70-1049-COM0024	Inclusive® Titanium Abutment 4.5 mmH* RP	70-1049-COM0024	\$35
 70-1049-COM0002	Inclusive® Titanium Abutment 6 mmH* RP	70-1049-COM0002	\$35
 70-1049-COM0026	Inclusive® Titanium Abutment 4.5 mmH, Non-Engaging* RP <i>(Titanium Screw Unigrip™ sold separately; please see page 34.)</i>	70-1049-COM0026	\$35

TITANIUM ABUTMENT BLANKS

 70-1049-COM0016	Inclusive® Titanium Abutment Blank* RP	70-1049-COM0016	\$30
--	--	-----------------	------

*compatible with: Nobel Biocare Brånemark System®

Implant components compatible with: Nobel Biocare Brånemark System®

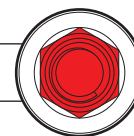

Brånemark System and Unigrip are trademarks of the Nobel Biocare group.

UCLA PLASTIC ABUTMENTS



70-1049-COM0063

Description (with Platform Size)	Code	Price
Inclusive® UCLA Plastic Abutment* RP	70-1049-COM0063	\$35



70-1049-COM0064

Inclusive® UCLA Plastic Abutment, Non-Engaging* RP <i>(UCLA Abutments include Titanium Screw Unigrip™ and Guide Pin Unigrip™.)</i>	70-1049-COM0064	\$35
---	-----------------	------

TITANIUM SCREWS AND GUIDE PINS (UNIGRIP™)



70-1049-COM0040
70-1049-COM0011

Inclusive® Titanium Screw* RP	70-1049-COM0040	\$12
Inclusive® Titanium Screw (5-pack)* RP	70-1049-COM0011	\$50

MULTI-UNIT ABUTMENTS



70-1049-COM0049



70-1049-COM0050



70-1049-COM0051



70-1049-COM0052

Inclusive® Multi-Unit Abutment 1 mmH* RP	70-1049-COM0049	\$100
Inclusive® Multi-Unit Abutment 2 mmH* RP	70-1049-COM0050	\$100
Inclusive® Multi-Unit Abutment 3 mmH* RP	70-1049-COM0051	\$100
Inclusive® Multi-Unit Abutment 5 mmH* RP	70-1049-COM0052	\$100

(Prosthetic Screw sold separately; please see page 11.)



70-1049-COM0053



70-1049-COM0054



70-1049-COM0055

Inclusive® 17° Multi-Unit Abutment 2 mmH* RP	70-1049-COM0053	\$100
Inclusive® 17° Multi-Unit Abutment 3 mmH* RP	70-1049-COM0054	\$100
Inclusive® 17° Multi-Unit Abutment 4 mmH* RP	70-1049-COM0055	\$100



70-1049-COM0056



70-1049-COM0057

Inclusive® 30° Multi-Unit Abutment 4 mmH* RP	70-1049-COM0056	\$100
Inclusive® 30° Multi-Unit Abutment 5 mmH* RP	70-1049-COM0057	\$100

(Angled Multi-Unit Abutments include Angled Abutment Screw. Prosthetic Screw sold separately; please see page 11.)

MULTI-UNIT TITANIUM SCREWS



70-1049-COM0058

Inclusive® Angled Multi-Unit Abutment Screw* RP	70-1049-COM0058	\$12
---	-----------------	------

MULTI-UNIT ABUTMENT ACCESSORIES

For a complete line of Multi-Unit Abutment Accessories, please see page 11.

**compatible with: Nobel Biocare Brånemark System®*

Implant components compatible with: Nobel Biocare NobelActive®

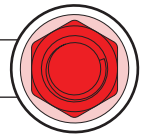









NobelActive and Unigrip are trademarks of the Nobel Biocare group.

IMPLANT ANALOGS





Description (with Platform Size)		Code	Price
 70-1050-COM0001	Inclusive® Implant Analog (5-pack)* NP	70-1050-COM0001	\$60
 70-1050-COM0002	Inclusive® Implant Analog (5-pack)* RP	70-1050-COM0002	\$60

SCANNING ABUTMENTS

 70-1050-COM0066	Clinical Use (radiopaque) Inclusive® Clinical Scanning Abutment, Anterior* NP	70-1050-COM0066	\$15
 70-1050-COM0067	Inclusive® Clinical Scanning Abutment, Anterior* RP	70-1050-COM0067	\$15
 70-1050-COM0109	Clinical Use (radiopaque) Inclusive® Clinical Scanning Abutment, Posterior* NP	70-1050-COM0109	\$15
 70-1050-COM0110	Inclusive® Clinical Scanning Abutment, Posterior* RP	70-1050-COM0110	\$15
 70-1050-COM0105	Laboratory Packs (radiolucent) Inclusive® Laboratory Scanning Abutment (3-pack)* NP	70-1050-COM0105	\$45
 70-1050-COM0106	Inclusive® Laboratory Scanning Abutment (3-pack)* RP	70-1050-COM0106	\$45
 70-1050-COM0135	Blue Light Scanner Laboratory Packs (radiolucent) Inclusive® Laboratory Scanning Abutment† (3-pack)* NP	70-1050-COM0135	\$45
 70-1050-COM0136	Inclusive® Laboratory Scanning Abutment† (3-pack)* RP	70-1050-COM0136	\$45







†for Blue Light Scanners
(Scanning Abutments include Captured Screw.)

BITE VERIFICATION CYLINDERS

 70-1050-COM0072	Inclusive® Bite Verification Cylinder* NP	70-1050-COM0072	\$30
 70-1050-COM0073	Inclusive® Bite Verification Cylinder* RP	70-1050-COM0073	\$30
 70-1050-COM0070	Inclusive® Bite Verification Cylinder, Non-Engaging* NP	70-1050-COM0070	\$30
 70-1050-COM0071	Inclusive® Bite Verification Cylinder, Non-Engaging* RP	70-1050-COM0071	\$30

(Bite Verification Cylinders include Titanium Screw Unigrip™ and Guide Pin Unigrip™.)

TITANIUM ABUTMENTS

 70-1050-COM0046	Inclusive® Titanium Abutment 4.5 mmH* NP	70-1050-COM0046	\$35
 70-1050-COM0048	Inclusive® Titanium Abutment 4.5 mmH* RP	70-1050-COM0048	\$35
 70-1050-COM0021	Inclusive® Titanium Abutment 6 mmH* NP	70-1050-COM0021	\$35
 70-1050-COM0022	Inclusive® Titanium Abutment 6 mmH* RP	70-1050-COM0022	\$35
 70-1050-COM0050	Inclusive® Titanium Abutment 4.5 mmH, Non-Engaging* NP	70-1050-COM0050	\$35
 70-1050-COM0052	Inclusive® Titanium Abutment 4.5 mmH, Non-Engaging* RP	70-1050-COM0052	\$35

(Titanium Screw Unigrip™ sold separately; please see page 36.)





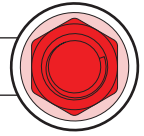

*compatible with: Nobel Biocare NobelActive®

Implant components compatible with: Nobel Biocare NobelActive®

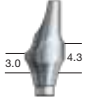

NobelActive and Unigrip are trademarks of the Nobel Biocare group.

TITANIUM ESTHETIC ABUTMENTS

	Description (with Platform Size)	Code	Price
	Inclusive® 15° Titanium Esthetic Abutment, Anterior* NP	70-1050-COM0091	\$85
	Inclusive® 15° Titanium Esthetic Abutment, Anterior* RP	70-1050-COM0092	\$85
	Inclusive® 15° Titanium Esthetic Abutment, Posterior* RP	70-1050-COM0093	\$85
	Inclusive® Titanium Esthetic Abutment, Anterior* NP	70-1050-COM0094	\$85
	Inclusive® Titanium Esthetic Abutment, Anterior* RP	70-1050-COM0095	\$85
	Inclusive® Titanium Esthetic Abutment, Posterior* RP	70-1050-COM0096	\$85

(Esthetic Abutments include Titanium Screw Unigrip™.)

TITANIUM ABUTMENT BLANKS

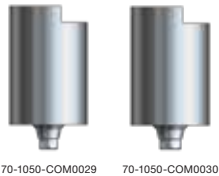

Inclusive® Titanium Abutment Blank* NP	70-1050-COM0029	\$30
Inclusive® Titanium Abutment Blank* RP	70-1050-COM0030	\$30

UCLA PLASTIC ABUTMENTS



Inclusive® UCLA Plastic Abutment* NP	70-1050-COM0097	\$35
Inclusive® UCLA Plastic Abutment* RP	70-1050-COM0098	\$35
Inclusive® UCLA Plastic Abutment, Non-Engaging* NP	70-1050-COM0099	\$35
Inclusive® UCLA Plastic Abutment, Non-Engaging* RP	70-1050-COM0100	\$35

(UCLA Abutments include Titanium Screw Unigrip™ and Guide Pin Unigrip™.)

TITANIUM SCREWS AND GUIDE PINS (UNIGRIP™)

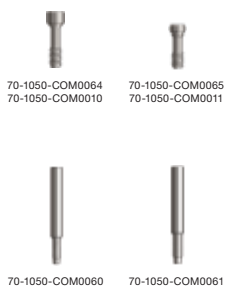

Inclusive® Titanium Screw* NP	70-1050-COM0064	\$12
Inclusive® Titanium Screw (5-pack)* NP	70-1050-COM0010	\$50
Inclusive® Titanium Screw* RP	70-1050-COM0065	\$12
Inclusive® Titanium Screw (5-pack)* RP	70-1050-COM0011	\$50
Inclusive® Guide Pin Implant Level 20 mm (5-pack)* NP	70-1050-COM0060	\$50
Inclusive® Guide Pin Implant Level 20 mm (5-pack)* RP	70-1050-COM0061	\$50

(Unigrip™ driver required.)

*compatible with: Nobel Biocare NobelActive®

Implant components compatible with: Nobel Biocare NobelActive®

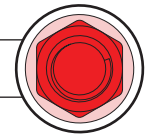



NobelActive and Unigrip are trademarks of the Nobel Biocare group.

MULTI-UNIT ABUTMENTS

	Description	Code	Price
	Inclusive® Multi-Unit Abutment 1.5 mmH* NP	70-1050-COM0074	\$100
	Inclusive® Multi-Unit Abutment 2.5 mmH* NP	70-1050-COM0075	\$100
	Inclusive® Multi-Unit Abutment 3.5 mmH* NP	70-1050-COM0076	\$100
	Inclusive® Multi-Unit Abutment 1.5 mmH* RP	70-1050-COM0077	\$100
	Inclusive® Multi-Unit Abutment 2.5 mmH* RP	70-1050-COM0078	\$100
	Inclusive® Multi-Unit Abutment 3.5 mmH* RP	70-1050-COM0079	\$100
	Inclusive® Multi-Unit Abutment 4.5 mmH* RP	70-1050-COM0080	\$100
<i>(Prosthetic Screw sold separately; please see page 11.)</i>			
	Inclusive® 17° Multi-Unit Abutment 2.5 mmH* NP	70-1050-COM0081	\$100
	Inclusive® 17° Multi-Unit Abutment 3.5 mmH* NP	70-1050-COM0082	\$100
	Inclusive® 17° Multi-Unit Abutment 2.5 mmH* RP	70-1050-COM0083	\$100
	Inclusive® 17° Multi-Unit Abutment 3.5 mmH* RP	70-1050-COM0084	\$100
	Inclusive® 30° Multi-Unit Abutment 3.5 mmH* NP	70-1050-COM0085	\$100
	Inclusive® 30° Multi-Unit Abutment 4.5 mmH* NP	70-1050-COM0086	\$100
	Inclusive® 30° Multi-Unit Abutment 3.5 mmH* RP	70-1050-COM0087	\$100
	Inclusive® 30° Multi-Unit Abutment 4.5 mmH* RP	70-1050-COM0088	\$100
<i>(Angled Multi-Unit Abutments include Angled Abutment Screw. Prosthetic Screw sold separately; please see page 11.)</i>			

MULTI-UNIT TITANIUM SCREWS

	Inclusive® Angled Multi-Unit Abutment Screw* NP	70-1050-COM0089	\$12
	Inclusive® Angled Multi-Unit Abutment Screw* RP	70-1050-COM0090	\$12

MULTI-UNIT ABUTMENT ACCESSORIES

For a complete line of Multi-Unit Abutment Accessories, please see page 11.

*compatible with: Nobel Biocare NobelActive®

Implant components compatible with: Nobel Biocare NobelReplace®

NobelReplace, Snappy, and Unigrip are trademarks of the Nobel Biocare group.

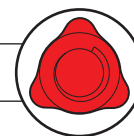

IMPLANT ANALOGS



Description (with Platform Size)	Code	Price
Inclusive® Implant Analog (5-pack)* NP	70-1051-COM0002	\$60
Inclusive® Implant Analog (5-pack)* RP	70-1051-COM0003	\$60
Inclusive® Implant Analog (5-pack)* WP	70-1051-COM0004	\$60
Inclusive® Implant Analog (5-pack)* 6.0	70-1051-COM0001	\$60

ABUTMENT ANALOGS



Inclusive® Analog, Snappy™ Abutment 4.0 (5-pack)* NP	70-1051-COM0111	\$75
Inclusive® Analog, Snappy™ Abutment 4.0 (5-pack)* RP	70-1051-COM0114	\$75



Inclusive® Analog, Snappy™ Abutment 4.0 (5-pack)* WP	70-1051-COM0117	\$75
Inclusive® Analog, Snappy™ Abutment 4.0 (5-pack)* 6.0	70-1051-COM0109	\$75



Inclusive® Analog, Snappy™ Abutment 5.5 (5-pack)* NP	70-1051-COM0123	\$75
Inclusive® Analog, Snappy™ Abutment 5.5 (5-pack)* RP	70-1051-COM0126	\$75



Inclusive® Analog, Snappy™ Abutment 5.5 (5-pack)* WP	70-1051-COM0129	\$75
Inclusive® Analog, Snappy™ Abutment 5.5 (5-pack)* 6.0	70-1051-COM0120	\$75

IMPRESSION TRANSFERS



Inclusive® Transfer Coping 3.5 mmD, Closed-Tray* NP	70-1051-COM0235	\$28
Inclusive® Transfer Coping 4.3 mmD, Closed-Tray* RP	70-1051-COM0236	\$28
Inclusive® Transfer Coping 5.0 mmD, Closed-Tray* WP	70-1051-COM0237	\$28







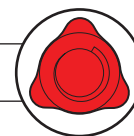











Inclusive® Transfer Coping 3.5 mmD, Open-Tray* NP	70-1051-COM0238	\$28
Inclusive® Transfer Coping 4.3 mmD, Open-Tray* RP	70-1051-COM0239	\$28
Inclusive® Transfer Coping 5.0 mmD, Open-Tray* WP	70-1051-COM0240	\$28





*compatible with: Nobel Biocare NobelReplace®



SCANNING ABUTMENTS

Description (with Platform Size)		Code	Price
			
70-1051-COM0155	70-1051-COM0156		
Clinical Use (radiopaque)			
Inclusive® Clinical Scanning Abutment, Anterior* NP		70-1051-COM0155	\$15
Inclusive® Clinical Scanning Abutment, Anterior* RP		70-1051-COM0156	\$15
Inclusive® Clinical Scanning Abutment, Anterior* WP		70-1051-COM0157	\$15
Inclusive® Clinical Scanning Abutment, Anterior* 6.0		70-1051-COM0158	\$15
			
70-1051-COM0157	70-1051-COM0158		
			
70-1051-COM0229	70-1051-COM0230		
Clinical Use (radiopaque)			
Inclusive® Clinical Scanning Abutment, Posterior* NP		70-1051-COM0229	\$15
Inclusive® Clinical Scanning Abutment, Posterior* RP		70-1051-COM0230	\$15
Inclusive® Clinical Scanning Abutment, Posterior* WP		70-1051-COM0231	\$15
Inclusive® Clinical Scanning Abutment, Posterior* 6.0		70-1051-COM0232	\$15
			
70-1051-COM0231	70-1051-COM0232		
			
70-1051-COM0215	70-1051-COM0216		
Laboratory Packs (radiolucent)			
Inclusive® Laboratory Scanning Abutment (3-pack)* NP		70-1051-COM0215	\$45
Inclusive® Laboratory Scanning Abutment (3-pack)* RP		70-1051-COM0216	\$45
Inclusive® Laboratory Scanning Abutment (3-pack)* WP		70-1051-COM0217	\$45
Inclusive® Laboratory Scanning Abutment (3-pack)* 6.0		70-1051-COM0218	\$45
			
70-1051-COM0217	70-1051-COM0218		
			
70-1051-COM0257	70-1051-COM0258		
Blue Light Scanner Laboratory Packs (radiolucent)			
Inclusive® Laboratory Scanning Abutment† (3-pack)* NP		70-1051-COM0257	\$45
Inclusive® Laboratory Scanning Abutment† (3-pack)* RP		70-1051-COM0258	\$45
Inclusive® Laboratory Scanning Abutment† (3-pack)* WP		70-1051-COM0259	\$45
Inclusive® Laboratory Scanning Abutment† (3-pack)* 6.0		70-1051-COM0260	\$45
			
70-1051-COM0259	70-1051-COM0260		
†for Blue Light Scanners (Scanning Abutments include Captured Screw.)			

BITE VERIFICATION CYLINDERS

			
70-1051-COM0167	70-1051-COM0168		
Inclusive® Bite Verification Cylinder* NP		70-1051-COM0167	\$30
Inclusive® Bite Verification Cylinder* RP		70-1051-COM0168	\$30
			
70-1051-COM0169	70-1051-COM0170		
Inclusive® Bite Verification Cylinder* WP		70-1051-COM0169	\$30
Inclusive® Bite Verification Cylinder* 6.0		70-1051-COM0170	\$30
(Bite Verification Cylinders include Titanium Screw Unigrip™ and Guide Pin Unigrip™.)			

*compatible with: Nobel Biocare NobelReplace®

Implant components compatible with: Nobel Biocare NobelReplace®

NobelReplace, Snappy, and Unigrip are trademarks of the Nobel Biocare group.

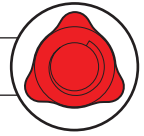

BITE VERIFICATION CYLINDERS



Description (with Platform Size)	Code	Price
Inclusive® Bite Verification Cylinder, Non-Engaging* NP	70-1051-COM0163	\$30
Inclusive® Bite Verification Cylinder, Non-Engaging* RP	70-1051-COM0164	\$30
Inclusive® Bite Verification Cylinder, Non-Engaging* WP	70-1051-COM0165	\$30
Inclusive® Bite Verification Cylinder, Non-Engaging* 6.0	70-1051-COM0166	\$30

(Bite Verification Cylinders include Titanium Screw Unigrip™ and Guide Pin Unigrip™.)

TITANIUM ABUTMENTS



Inclusive® Titanium Abutment 4.5 mmH* NP	70-1051-COM0090	\$35
Inclusive® Titanium Abutment 4.5 mmH* RP	70-1051-COM0092	\$35
Inclusive® Titanium Abutment 4.5 mmH* WP	70-1051-COM0094	\$35
Inclusive® Titanium Abutment 4.5 mmH* 6.0	70-1051-COM0088	\$35
Inclusive® Titanium Abutment 6 mmH* NP	70-1051-COM0048	\$35
Inclusive® Titanium Abutment 6 mmH* RP	70-1051-COM0049	\$35
Inclusive® Titanium Abutment 6 mmH* WP	70-1051-COM0050	\$35
Inclusive® Titanium Abutment 6 mmH* 6.0	70-1051-COM0047	\$35
Inclusive® Titanium Abutment 4.5 mmH, Non-Engaging* NP	70-1051-COM0098	\$35
Inclusive® Titanium Abutment 4.5 mmH, Non-Engaging* RP	70-1051-COM0100	\$35
Inclusive® Titanium Abutment 4.5 mmH, Non-Engaging* WP	70-1051-COM0102	\$35
Inclusive® Titanium Abutment 4.5 mmH, Non-Engaging* 6.0	70-1051-COM0096	\$35

(Titanium Screw Unigrip™ sold separately; please see page 41.)

TITANIUM ESTHETIC ABUTMENTS

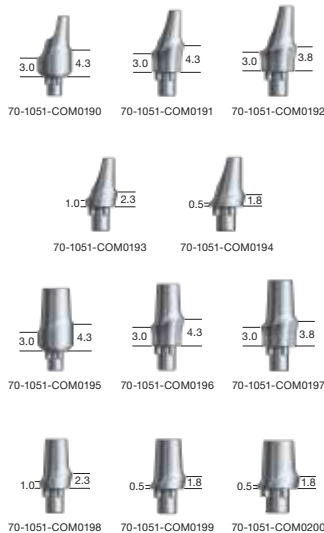

Inclusive® 15° Titanium Esthetic Abutment, Anterior* NP	70-1051-COM0190	\$85
Inclusive® 15° Titanium Esthetic Abutment, Anterior* RP	70-1051-COM0191	\$85
Inclusive® 15° Titanium Esthetic Abutment, Anterior* WP	70-1051-COM0192	\$85
Inclusive® 15° Titanium Esthetic Abutment, Posterior* RP	70-1051-COM0193	\$85
Inclusive® 15° Titanium Esthetic Abutment, Posterior* WP	70-1051-COM0194	\$85
Inclusive® Titanium Esthetic Abutment, Anterior* NP	70-1051-COM0195	\$85
Inclusive® Titanium Esthetic Abutment, Anterior* RP	70-1051-COM0196	\$85
Inclusive® Titanium Esthetic Abutment, Anterior* WP	70-1051-COM0197	\$85
Inclusive® Titanium Esthetic Abutment, Posterior* RP	70-1051-COM0198	\$85
Inclusive® Titanium Esthetic Abutment, Posterior* WP	70-1051-COM0199	\$85
Inclusive® Titanium Esthetic Abutment, Posterior* 6.0	70-1051-COM0200	\$85

(Esthetic Abutments include Titanium Screw Unigrip™.)



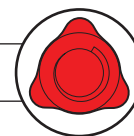

*compatible with: Nobel Biocare NobelReplace®

Implant components compatible with: Nobel Biocare NobelReplace®













NobelReplace, Snappy, and Unigrip are trademarks of the Nobel Biocare group.



TITANIUM ABUTMENT BLANKS







Description (with Platform Size)		Code	Price
	Inclusive® Titanium Abutment Blank* NP	70-1051-COM0056	\$30
	Inclusive® Titanium Abutment Blank* RP	70-1051-COM0057	\$30
	Inclusive® Titanium Abutment Blank* WP	70-1051-COM0058	\$30
	Inclusive® Titanium Abutment Blank* 6.0	70-1051-COM0055	\$30

UCLA ABUTMENTS

	Inclusive® UCLA Gold Abutment* NP	70-1051-COM0211	\$100
	Inclusive® UCLA Gold Abutment* RP	70-1051-COM0212	\$100
	Inclusive® UCLA Gold Abutment* WP	70-1051-COM0213	\$100
	Inclusive® UCLA Gold Abutment* 6.0	70-1051-COM0214	\$100
	Inclusive® UCLA Plastic Abutment* NP	70-1051-COM0201	\$35
	Inclusive® UCLA Plastic Abutment* RP	70-1051-COM0202	\$35
	Inclusive® UCLA Plastic Abutment* WP	70-1051-COM0203	\$35
	Inclusive® UCLA Plastic Abutment* 6.0	70-1051-COM0204	\$35
	Inclusive® UCLA Plastic Abutment, Non-Engaging* NP	70-1051-COM0205	\$35
	Inclusive® UCLA Plastic Abutment, Non-Engaging* RP	70-1051-COM0206	\$35
	Inclusive® UCLA Plastic Abutment, Non-Engaging* WP	70-1051-COM0207	\$35
	Inclusive® UCLA Plastic Abutment, Non-Engaging* 6.0	70-1051-COM0208	\$35

(UCLA Abutments include Titanium Screw Unigrip™ and Guide Pin Unigrip™.)

TITANIUM SCREWS AND GUIDE PINS (UNIGRIP™)

	Inclusive® Titanium Screw* NP	70-1051-COM0153	\$12
	Inclusive® Titanium Screw (5-pack)* NP	70-1051-COM0019	\$50
	Inclusive® Titanium Screw* RP/WP/6.0	70-1051-COM0154	\$12
	Inclusive® Titanium Screw (5-pack)* RP/WP/6.0	70-1051-COM0020	\$50
	Inclusive® Guide Pin Implant Level 20 mm (5-pack)* NP	70-1051-COM0142	\$50
	Inclusive® Guide Pin Implant Level 20 mm (5-pack)* RP/WP/6.0	70-1051-COM0144	\$50

(Unigrip™ driver required.)

*compatible with: Nobel Biocare NobelReplace®

Implant components compatible with: Nobel Biocare NobelReplace®

NobelReplace, Snappy, and Unigrip are trademarks of the Nobel Biocare group.

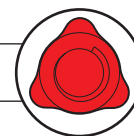

MULTI-UNIT ABUTMENTS

	Description	Code	Price
	Inclusive® Multi-Unit Abutment 1 mmH* NP	70-1051-COM0171	\$100
	Inclusive® Multi-Unit Abutment 2 mmH* NP	70-1051-COM0172	\$100
	Inclusive® Multi-Unit Abutment 3 mmH* NP	70-1051-COM0173	\$100
	Inclusive® Multi-Unit Abutment 1 mmH* RP	70-1051-COM0174	\$100
	Inclusive® Multi-Unit Abutment 2 mmH* RP	70-1051-COM0175	\$100
	Inclusive® Multi-Unit Abutment 3 mmH* RP	70-1051-COM0176	\$100
	Inclusive® Multi-Unit Abutment 5 mmH* RP	70-1051-COM0177	\$100
	Inclusive® Multi-Unit Abutment 1 mmH* WP	70-1051-COM0178	\$100
	Inclusive® Multi-Unit Abutment 2 mmH* WP	70-1051-COM0179	\$100
	Inclusive® Multi-Unit Abutment 3 mmH* WP	70-1051-COM0180	\$100
	<i>(Prosthetic Screw sold separately; please see page 11.)</i>		
	Inclusive® 17° Multi-Unit Abutment 2 mmH* NP	70-1051-COM0181	\$100
	Inclusive® 17° Multi-Unit Abutment 3 mmH* NP	70-1051-COM0182	\$100
	Inclusive® 17° Multi-Unit Abutment 2 mmH* RP	70-1051-COM0183	\$100
	Inclusive® 17° Multi-Unit Abutment 3 mmH* RP	70-1051-COM0184	\$100
	Inclusive® 17° Multi-Unit Abutment 4 mmH* RP	70-1051-COM0185	\$100
	Inclusive® 30° Multi-Unit Abutment 4 mmH* RP	70-1051-COM0186	\$100
	Inclusive® 30° Multi-Unit Abutment 5 mmH* RP	70-1051-COM0187	\$100
	<i>(Angled Multi-Unit Abutments include Angled Abutment Screw. Prosthetic Screw sold separately; please see page 11.)</i>		

MULTI-UNIT TITANIUM SCREWS



Inclusive® Angled Multi-Unit Abutment Screw* NP 70-1051-COM0188 \$12



Inclusive® Angled Multi-Unit Abutment Screw* RP 70-1051-COM0189 \$12

MULTI-UNIT ABUTMENT ACCESSORIES

For a complete line of Multi-Unit Abutment Accessories, please see page 11.

*compatible with: Nobel Biocare NobelReplace®

Implant components compatible with: **Straumann® Bone Level**



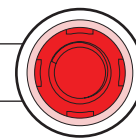





Straumann is a registered trademark of Straumann Holding AG.



IMPLANT ANALOGS





Description (with Platform Size)		Code	Price
	Inclusive® Implant Analog (5-pack)* NC	70-1052-COM0007	\$60
	Inclusive® Implant Analog (5-pack)* RC	70-1052-COM0008	\$60

SCANNING ABUTMENTS

	<i>Clinical Use (radiopaque)</i> Inclusive® Clinical Scanning Abutment, Anterior* NC	70-1052-COM0066	\$15
	Inclusive® Clinical Scanning Abutment, Anterior* RC	70-1052-COM0067	\$15
	<i>Clinical Use (radiopaque)</i> Inclusive® Clinical Scanning Abutment, Posterior* NC	70-1052-COM0109	\$15
	Inclusive® Clinical Scanning Abutment, Posterior* RC	70-1052-COM0110	\$15
	<i>Laboratory Packs (radiolucent)</i> Inclusive® Laboratory Scanning Abutment (3-pack)* NC	70-1052-COM0101	\$45
	Inclusive® Laboratory Scanning Abutment (3-pack)* RC	70-1052-COM0102	\$45
	<i>Blue Light Scanner Laboratory Packs (radiolucent)</i> Inclusive® Laboratory Scanning Abutment† (3-pack)* NC	70-1052-COM0135	\$45
	Inclusive® Laboratory Scanning Abutment† (3-pack)* RC	70-1052-COM0136	\$45





†for Blue Light Scanners
(Scanning Abutments include Captured Screw.)

BITE VERIFICATION CYLINDERS

	Inclusive® Bite Verification Cylinder* NC	70-1052-COM0072	\$30
	Inclusive® Bite Verification Cylinder* RC	70-1052-COM0073	\$30
	Inclusive® Bite Verification Cylinder, Non-Engaging* NC	70-1052-COM0070	\$30
	Inclusive® Bite Verification Cylinder, Non-Engaging* RC	70-1052-COM0071	\$30

(Bite Verification Cylinders include SCS Titanium Screw and SCS Guide Pin.)

TITANIUM ABUTMENTS

	Inclusive® Titanium Abutment 4.5 mmH* NC	70-1052-COM0045	\$35
	Inclusive® Titanium Abutment 4.5 mmH* RC	70-1052-COM0047	\$35
	Inclusive® Titanium Abutment 6 mmH* NC	70-1052-COM0003	\$35
	Inclusive® Titanium Abutment 6 mmH* RC	70-1052-COM0004	\$35

(SCS Titanium Screw sold separately; please see page 44.)

*compatible with: Straumann® Bone Level

Implant components compatible with: **Straumann® Bone Level**

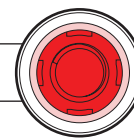

Straumann is a registered trademark of Straumann Holding AG.

TITANIUM ABUTMENTS



Description (with Platform Size)	Code	Price
Inclusive® Titanium Abutment 4.5 mmH, Non-Engaging* NC	70-1052-COM0049	\$35
Inclusive® Titanium Abutment 4.5 mmH, Non-Engaging* RC	70-1052-COM0051	\$35

(SCS Titanium Screw sold separately; please see below.)

TITANIUM ESTHETIC ABUTMENTS



Inclusive® 15° Titanium Esthetic Abutment, Anterior* NC	70-1052-COM0089	\$85
Inclusive® 15° Titanium Esthetic Abutment, Anterior* RC	70-1052-COM0090	\$85
Inclusive® 15° Titanium Esthetic Abutment, Posterior* RC	70-1052-COM0091	\$85



Inclusive® Titanium Esthetic Abutment, Anterior* NC	70-1052-COM0092	\$85
Inclusive® Titanium Esthetic Abutment, Anterior* RC	70-1052-COM0093	\$85
Inclusive® Titanium Esthetic Abutment, Posterior* RC	70-1052-COM0094	\$85

(Esthetic Abutments include SCS Titanium Screw.)

TITANIUM ABUTMENT BLANKS



Inclusive® Titanium Abutment Blank* NC	70-1052-COM0030	\$30
Inclusive® Titanium Abutment Blank* RC	70-1052-COM0031	\$30

UCLA PLASTIC ABUTMENTS

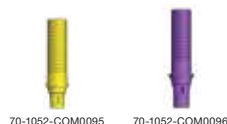

Inclusive® UCLA Plastic Abutment* NC	70-1052-COM0095	\$35
Inclusive® UCLA Plastic Abutment* RC	70-1052-COM0096	\$35

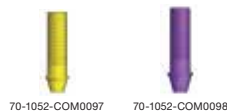

Inclusive® UCLA Plastic Abutment, Non-Engaging* NC	70-1052-COM0097	\$35
Inclusive® UCLA Plastic Abutment, Non-Engaging* RC	70-1052-COM0098	\$35

(UCLA Abutments include SCS Titanium Screw and SCS Guide Pin.)

SCS TITANIUM SCREWS AND GUIDE PINS



Inclusive® Titanium Screw* NC	70-1052-COM0064	\$12
Inclusive® Titanium Screw (5-pack)* NC	70-1052-COM0020	\$50



Inclusive® Titanium Screw* RC	70-1052-COM0065	\$12
Inclusive® Titanium Screw (5-pack)* RC	70-1052-COM0021	\$50

(SCS driver required.)

*compatible with: **Straumann® Bone Level**

Implant components compatible with: **Straumann® Bone Level**

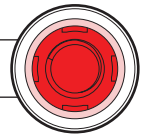

Straumann is a registered trademark of Straumann Holding AG.

SCS TITANIUM SCREWS AND GUIDE PINS



70-1052-COM0059 70-1052-COM0061

Description (with Platform Size)	Code	Price
Inclusive® Guide Pin (5-pack)* NC	70-1052-COM0059	\$50
Inclusive® Guide Pin (5-pack)* RC	70-1052-COM0061	\$50

(SCS driver required.)

MULTI-UNIT ABUTMENTS



70-1052-COM0074 70-1052-COM0075 70-1052-COM0076

Inclusive® Multi-Unit Abutment 1.5 mmH* NC	70-1052-COM0074	\$100
Inclusive® Multi-Unit Abutment 2.5 mmH* NC	70-1052-COM0075	\$100
Inclusive® Multi-Unit Abutment 3.5 mmH* NC	70-1052-COM0076	\$100

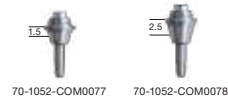

70-1052-COM0077 70-1052-COM0078

Inclusive® Multi-Unit Abutment 1.5 mmH* RC	70-1052-COM0077	\$100
Inclusive® Multi-Unit Abutment 2.5 mmH* RC	70-1052-COM0078	\$100



70-1052-COM0079 70-1052-COM0080

Inclusive® Multi-Unit Abutment 3.5 mmH* RC	70-1052-COM0079	\$100
Inclusive® Multi-Unit Abutment 4.5 mmH* RC	70-1052-COM0080	\$100

(Prosthetic Screw sold separately; please see page 11.)



70-1052-COM0081 70-1052-COM0082

Inclusive® 17° Multi-Unit Abutment 2.5 mmH* NC	70-1052-COM0081	\$100
Inclusive® 17° Multi-Unit Abutment 3.5 mmH* NC	70-1052-COM0082	\$100



70-1052-COM0083 70-1052-COM0084

Inclusive® 17° Multi-Unit Abutment 2.5 mmH* RC	70-1052-COM0083	\$100
Inclusive® 17° Multi-Unit Abutment 3.5 mmH* RC	70-1052-COM0084	\$100



70-1052-COM0085 70-1052-COM0086

Inclusive® 30° Multi-Unit Abutment 3.5 mmH* RC	70-1052-COM0085	\$100
Inclusive® 30° Multi-Unit Abutment 4.5 mmH* RC	70-1052-COM0086	\$100

(Angled Multi-Unit Abutments include Angled Abutment Screw. Prosthetic Screw sold separately; please see page 11.)

MULTI-UNIT TITANIUM SCREWS



70-1052-COM0087

Inclusive® Angled Multi-Unit Abutment Screw* NC/RC	70-1052-COM0087	\$12
--	-----------------	------

MULTI-UNIT ABUTMENT ACCESSORIES

For a complete line of Multi-Unit Abutment Accessories, please see page 11.

**compatible with: Straumann® Bone Level*

Implant components compatible with: Straumann® Tissue Level

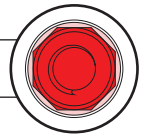

Straumann and synOcta are registered trademarks of Straumann Holding AG.

IMPLANT ANALOGS



Description (with Platform Size)	Code	Price
Inclusive® Implant Analog (5-pack)* NN	70-1053-COM0006	\$60
Inclusive® Implant Analog (5-pack)* RN synOcta®	70-1053-COM0007	\$60
Inclusive® Implant Analog (5-pack)* WN synOcta®	70-1053-COM0008	\$60

ABUTMENT ANALOGS



Inclusive® Analog, Solid Abutment 14.3 mmL (5-pack)* RN synOcta®	70-1053-COM0020	\$75
Inclusive® Analog, Solid Abutment 15.8 mmL (5-pack)* RN synOcta®	70-1053-COM0023	\$75
Inclusive® Analog, Solid Abutment 17.3 mmL (5-pack)* RN synOcta®	70-1053-COM0026	\$75



Inclusive® Analog, Solid Abutment 16 mmL (5-pack)* WN synOcta®	70-1053-COM0029	\$75
Inclusive® Analog, Solid Abutment 17.5 mmL (5-pack)* WN synOcta®	70-1053-COM0032	\$75

SCANNING ABUTMENTS



Clinical Use (radiopaque)

Inclusive® Clinical Scanning Abutment, Posterior* RN synOcta®	70-1053-COM0043	\$15
Inclusive® Clinical Scanning Abutment, Posterior* WN synOcta®	70-1053-COM0044	\$15



Laboratory Packs (radiolucent)

Inclusive® Laboratory Scanning Abutment (3-pack)* RN synOcta®	70-1053-COM0041	\$45
Inclusive® Laboratory Scanning Abutment (3-pack)* WN synOcta®	70-1053-COM0042	\$45



Blue Light Scanner Laboratory Packs (radiolucent)

Inclusive® Laboratory Scanning Abutment† (3-pack)* RN synOcta®	70-1053-COM0087	\$45
Inclusive® Laboratory Scanning Abutment† (3-pack)* WN synOcta®	70-1053-COM0088	\$45

†for Blue Light Scanners

(Scanning Abutments include Captured Screw.)

BITE VERIFICATION CYLINDERS

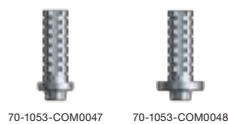

Inclusive® Bite Verification Cylinder, Non-Engaging* RN synOcta®	70-1053-COM0047	\$30
Inclusive® Bite Verification Cylinder, Non-Engaging* WN synOcta®	70-1053-COM0048	\$30

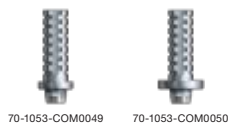

Inclusive® Bite Verification Cylinder* RN synOcta®	70-1053-COM0049	\$30
Inclusive® Bite Verification Cylinder* WN synOcta®	70-1053-COM0050	\$30

(Bite Verification Cylinders include SCS Titanium Screw and SCS Guide Pin.)





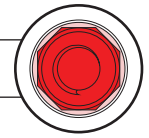

*compatible with: Straumann® Tissue Level

Implant components compatible with: **Straumann® Tissue Level**











Straumann and synOcta are registered trademarks of Straumann Holding AG.





TITANIUM ABUTMENTS

Description (with Platform Size)		Code	Price
		Inclusive® Titanium Abutment 4.5 mmH* RN synOcta®	70-1053-COM0059 \$35
70-1053-COM0059	70-1053-COM0060	Inclusive® Titanium Abutment 4.5 mmH* WN synOcta®	70-1053-COM0060 \$35
		Inclusive® Titanium Abutment 6 mmH* RN synOcta®	70-1053-COM0061 \$35
70-1053-COM0061	70-1053-COM0062	Inclusive® Titanium Abutment 6 mmH* WN synOcta®	70-1053-COM0062 \$35
		Inclusive® Titanium Abutment 4.5 mmH, Non-Engaging* RN synOcta®	70-1053-COM0057 \$35
70-1053-COM0057	70-1053-COM0058	Inclusive® Titanium Abutment 4.5 mmH, Non-Engaging* WN synOcta®	70-1053-COM0058 \$35



UCLA ABUTMENTS

		Inclusive® UCLA Gold Abutment* RN synOcta®	70-1053-COM0037 \$100
70-1053-COM0037	70-1053-COM0038	Inclusive® UCLA Gold Abutment* WN synOcta®	70-1053-COM0038 \$100
		Inclusive® UCLA Gold Abutment, Non-Engaging* RN synOcta®	70-1053-COM0039 \$100
70-1053-COM0039	70-1053-COM0040	Inclusive® UCLA Gold Abutment, Non-Engaging* WN synOcta®	70-1053-COM0040 \$100
		Inclusive® UCLA Plastic Abutment* RN synOcta®	70-1053-COM0055 \$35
70-1053-COM0055	70-1053-COM0056	Inclusive® UCLA Plastic Abutment* WN synOcta®	70-1053-COM0056 \$35
		Inclusive® UCLA Plastic Abutment, Non-Engaging* RN synOcta®	70-1053-COM0053 \$35
70-1053-COM0053	70-1053-COM0054	Inclusive® UCLA Plastic Abutment, Non-Engaging* WN synOcta®	70-1053-COM0054 \$35

SCS TITANIUM SCREWS

		Inclusive® Titanium Occlusal Screw* NN	70-1053-COM0035 \$15
70-1053-COM0035	70-1053-COM0036	Inclusive® Titanium Occlusal Screw (5-pack)* NN	70-1053-COM0036 \$50
		Inclusive® Titanium Basal Screw* RN/WN synOcta®	70-1053-COM0034 \$12
70-1053-COM0036	70-1053-COM0009	Inclusive® Titanium Basal Screw (5-pack)* RN/WN synOcta®	70-1053-COM0009 \$50
		Inclusive® Guide Pin (5-pack)* RN/WN synOcta®	70-1053-COM0072 \$50
70-1053-COM0072		<i>(SCS driver required)</i>	

MULTI-UNIT ABUTMENTS

		Inclusive® Multi-Unit Abutment 1 mmH* RN synOcta®	70-1053-COM0045 \$100
70-1053-COM0045	70-1053-COM0046	Inclusive® Multi-Unit Abutment 1.5 mmH* WN synOcta®	70-1053-COM0046 \$100

MULTI-UNIT ABUTMENT ACCESSORIES

For a complete line of Multi-Unit Abutment Accessories, please see page 11.

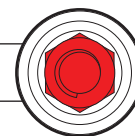

**compatible with: Straumann® Tissue Level*

Implant components compatible with: Zimmer Dental Screw-Vent®









Screw-Vent is a registered trademark of Zimmer Dental Inc.



IMPLANT ANALOGS



Description (with Platform Size)			Code	Price	
			Inclusive® Implant Analog (5-pack)* 3.5 mm	70-1054-COM0010	\$60
			Inclusive® Implant Analog (5-pack)* 4.5 mm	70-1054-COM0011	\$60
			Inclusive® Implant Analog (5-pack)* 5.7 mm	70-1054-COM0012	\$60

SCANNING ABUTMENTS

Clinical Use (radiopaque)					
			Inclusive® Clinical Scanning Abutment, Anterior* 3.5 mm	70-1054-COM0088	\$15
			Inclusive® Clinical Scanning Abutment, Anterior* 4.5 mm	70-1054-COM0089	\$15
			Inclusive® Clinical Scanning Abutment, Anterior* 5.7 mm	70-1054-COM0090	\$15

Clinical Use (radiopaque)					
			Inclusive® Clinical Scanning Abutment, Posterior* 3.5 mm	70-1054-COM0115	\$15
			Inclusive® Clinical Scanning Abutment, Posterior* 4.5 mm	70-1054-COM0116	\$15
			Inclusive® Clinical Scanning Abutment, Posterior* 5.7 mm	70-1054-COM0117	\$15



Laboratory Packs (radiolucent)					
			Inclusive® Laboratory Scanning Abutment (3-pack)* 3.5 mm	70-1054-COM0106	\$45
			Inclusive® Laboratory Scanning Abutment (3-pack)* 4.5 mm	70-1054-COM0107	\$45
			Inclusive® Laboratory Scanning Abutment (3-pack)* 5.7 mm	70-1054-COM0108	\$45



Blue Light Scanner Laboratory Packs (radiolucent)					
			Inclusive® Laboratory Scanning Abutment† (3-pack)* 3.5 mm	70-1054-COM0151	\$45
			Inclusive® Laboratory Scanning Abutment† (3-pack)* 4.5 mm	70-1054-COM0152	\$45
			Inclusive® Laboratory Scanning Abutment† (3-pack)* 5.7 mm	70-1054-COM0153	\$45

†for Blue Light Scanners

(Scanning Abutments include Captured Screw.)

BITE VERIFICATION CYLINDERS

			Inclusive® Bite Verification Cylinder* 3.5 mm	70-1054-COM0097	\$30
			Inclusive® Bite Verification Cylinder* 4.5 mm	70-1054-COM0098	\$30
			Inclusive® Bite Verification Cylinder* 5.7 mm	70-1054-COM0099	\$30

			Inclusive® Bite Verification Cylinder, Non-Engaging* 3.5 mm	70-1054-COM0094	\$30
			Inclusive® Bite Verification Cylinder, Non-Engaging* 4.5 mm	70-1054-COM0095	\$30
			Inclusive® Bite Verification Cylinder, Non-Engaging* 5.7 mm	70-1054-COM0096	\$30

(Bite Verification Cylinders include Titanium Screw and Guide Pin.)





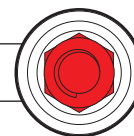



*compatible with: Zimmer Dental Screw-Vent®

Implant components compatible with: Zimmer Dental Screw-Vent®





Screw-Vent is a registered trademark of Zimmer Dental Inc.

TITANIUM ABUTMENTS





Description (with Platform Size)			Code	Price	
			Inclusive® Titanium Abutment 4.5 mmH* 3.5 mm	70-1054-COM0063	\$35
70-1054-COM0063	70-1054-COM0065	70-1054-COM0067	Inclusive® Titanium Abutment 4.5 mmH* 4.5 mm	70-1054-COM0065	\$35
			Inclusive® Titanium Abutment 4.5 mmH* 5.7 mm	70-1054-COM0067	\$35
			Inclusive® Titanium Abutment 6 mmH* 3.5 mm	70-1054-COM0004	\$35
70-1054-COM0004	70-1054-COM0005	70-1054-COM0006	Inclusive® Titanium Abutment 6 mmH* 4.5 mm	70-1054-COM0005	\$35
			Inclusive® Titanium Abutment 6 mmH* 5.7 mm	70-1054-COM0006	\$35
			Inclusive® Titanium Abutment 4.5 mmH, Non-Engaging* 3.5 mm	70-1054-COM0069	\$35
70-1054-COM0069	70-1054-COM0071	70-1054-COM0073	Inclusive® Titanium Abutment 4.5 mmH, Non-Engaging* 4.5 mm	70-1054-COM0071	\$35
			Inclusive® Titanium Abutment 4.5 mmH, Non-Engaging* 5.7 mm	70-1054-COM0073	\$35

(Titanium Screw sold separately; please see below.)

TITANIUM ABUTMENT BLANKS

			Inclusive® Titanium Abutment Blank* 3.5 mm	70-1054-COM0041	\$30
70-1054-COM0041	70-1054-COM0042	70-1054-COM0043	Inclusive® Titanium Abutment Blank* 4.5 mm	70-1054-COM0042	\$30
			Inclusive® Titanium Abutment Blank* 5.7 mm	70-1054-COM0043	\$30



UCLA PLASTIC ABUTMENTS

			Inclusive® UCLA Plastic Abutment* 3.5 mm	70-1054-COM0100	\$35
70-1054-COM0100	70-1054-COM0101	70-1054-COM0102	Inclusive® UCLA Plastic Abutment* 4.5 mm	70-1054-COM0101	\$35
			Inclusive® UCLA Plastic Abutment* 5.7 mm	70-1054-COM0102	\$35
			Inclusive® UCLA Plastic Abutment, Non-Engaging* 3.5 mm	70-1054-COM0103	\$35
70-1054-COM0103	70-1054-COM0104	70-1054-COM0105	Inclusive® UCLA Plastic Abutment, Non-Engaging* 4.5 mm	70-1054-COM0104	\$35
			Inclusive® UCLA Plastic Abutment, Non-Engaging* 5.7 mm	70-1054-COM0105	\$35

(UCLA Abutments include Titanium Screw and Guide Pin.)

TITANIUM SCREWS AND GUIDE PINS



	Inclusive® Titanium Screw* 3.5/4.5/5.7 mm	70-1054-COM0048	\$12
70-1054-COM0048	Inclusive® Titanium Screw (5-pack)* 3.5/4.5/5.7 mm	70-1054-COM0022	\$50
70-1054-COM0022			
	Inclusive® Guide Pin (5-pack)* 3.5/4.5/5.7 mm	70-1054-COM0084	\$50
70-1054-COM0084			

*compatible with: Zimmer Dental Screw-Vent®

INCLUSIVE® Prosthetic Kit

All instruments associated with the Inclusive Tapered Implant System are machined from high-quality, corrosion-resistant, surgical stainless steel, and feature standard ISO latch connectivity.

Description	Code	Price
Inclusive® Tapered Implant Prosthetic Kit	70-1071-PRS0001	\$750



Features and Benefits

The Inclusive Tapered Implant Prosthetic Kit allows the clinician to easily organize, store, and transport the prosthetic tooling of the Inclusive Tapered Implant System. The autoclavable kit is designed specifically for restorative doctors, to help simplify prosthetic procedures and instrument sterilization.

Sterilization

It is recommended that the prosthetic kit be steam-sterilized for fifteen (15) minutes at 132°C/270°F. Allow sterilized components to dry for at least thirty (30) minutes.

General Cleaning Tips:

- Observe universal precautions for the handling of contaminated or biohazardous materials.
- Clean promptly after each use, to prevent biological fluids and tissues from drying on the instruments.
- When applicable, disassemble parts and instruments prior to cleaning.
- Do not rely solely on automatic cleaning. Thorough manual cleaning is recommended.
- Preliminary cleaning should consist of wiping parts, soaking them in a lukewarm enzymatic solution for a minimum of twenty (20) minutes, and rinsing them with running water.
- Routine cleaning should consist of (a) washing parts using a broad spectrum cleaning solution, followed by thorough rinsing and drying; and (b) sonicate parts fully submerged in cleaning solution for at least ten (10) minutes, preferably at 45-50 kHz, followed by thorough rinsing and drying.
- Dry promptly and completely to avoid oxidation.

INCLUSIVE® Laboratory Scanning Abutment Kit

SCANNING ABUTMENT KIT

Description	Code	Price
Inclusive® Laboratory Scanning Abutment Kit	70-1073-PRA0039	\$995
Inclusive® Scanning Abutment Kit for Blue Light Scanners	70-1073-PRA0061	\$995

The Inclusive® Laboratory Scanning Abutment Kit, available for both traditional red-light and newer blue-light scanners, enables dental labs to maximize efficiency and value while taking advantage of Glidewell Laboratories' precise implant milling solutions.



Each kit contains a 3-pack of scanning abutments for the following implant platforms (99 scanning abutments in all):

- Biomet 3i™ Certain®
3.4 mm, 4.1 mm, 5.0 mm, 6.0 mm
- Camlog® Screw-Line
3.3 mm, 3.8 mm, 4.3 mm, 5.0 mm, 6.0 mm
- Dentsply Implants Ankylos® C/X
A/B/C/D
- Dentsply Implants Astra Tech Implant System®
3.0 (X-Small), 3.5/4.0 (Small), 4.5/5.0 (Large)
- Hiossen® HG System
Mini, Standard
- Keystone Dental PrimaConnex®
SD, RD, WD
- Neoss® Implant System
4.0 mm
- Nobel Biocare Brånemark System®
RP
- Nobel Biocare NobelActive®
NP, RP
- Nobel Biocare NobelReplace®
NP, RP, WP, 6.0 mm
- Straumann® Bone Level
NC, RC
- Straumann® Tissue Level
RN synOcta®, WN synOcta®
- Zimmer Dental Screw-Vent®
3.5 mm, 4.5 mm, 5.7 mm

Features and Benefits

Paired with the powerful 3Shape AbutmentDesigner™ module, the Inclusive Laboratory Scanning Abutment Kit can be used to scan and design custom implant abutments for 33 different restorative platforms spanning 13 major implant systems. Included with the kit is the Glidewell Digital Abutment Library, which provides custom morphology for the design of Inclusive-brand custom implant abutments, available in titanium and zirconia with a titanium base.

Parts Index

CODE	DESCRIPTION	PAGE	CODE	DESCRIPTION	PAGE
ANALOGS					
(BIOMET 3i™ Certain®)					
70-1047-COM0013	Implant Analog (5/pk) 3.4 mm	12	70-1054-COM0011	Implant Analog (5/pk) 4.5 mm	48
70-1047-COM0014	Implant Analog (5/pk) 4.1 mm	12	70-1054-COM0012	Implant Analog (5/pk) 5.7 mm	48
70-1047-COM0015	Implant Analog (5/pk) 5.0 mm	12	BITE VERIFICATION CYLINDERS		
70-1047-COM0016	Implant Analog (5/pk) 6.0 mm	12	(BIOMET 3i™ Certain®)		
(CAMLOG® SCREW-LINE)					
70-1135-CAM0068	Implant Analog (5/pk) 3.3 mm	16	70-1047-COM0130	Bite Verification Cylinder 3.4 mm	13
70-1135-CAM0070	Implant Analog (5/pk) 3.8 mm	16	70-1047-COM0131	Bite Verification Cylinder 4.1 mm	13
70-1135-CAM0072	Implant Analog (5/pk) 4.3 mm	16	70-1047-COM0132	Bite Verification Cylinder 5.0 mm	13
70-1135-CAM0074	Implant Analog (5/pk) 5.0 mm	16	70-1047-COM0133	Bite Verification Cylinder 6.0 mm	13
70-1135-CAM0076	Implant Analog (5/pk) 6.0 mm	16	70-1047-COM0126	Bite Verification Cylinder, Non-Engag 3.4 mm	13
(Dentsply Implants Ankylos® C/X)					
70-1139-COM0020	Implant Analog (5/pk) 3.5 A	20	70-1047-COM0127	Bite Verification Cylinder, Non-Engag 4.1 mm	13
70-1139-COM0021	Implant Analog (5/pk) 4.5 B	20	70-1047-COM0128	Bite Verification Cylinder, Non-Engag 5.0 mm	13
70-1139-COM0022	Implant Analog (5/pk) 5.5 C	20	70-1047-COM0129	Bite Verification Cylinder, Non-Engag 6.0 mm	13
(DENTSPLY Implants ASTRA TECH Implant System®)					
70-1048-COM0014	Implant Analog (5/pk) 3.0	22	(CAMLOG® SCREW-LINE)		
70-1048-COM0016	Implant Analog (5/pk) 3.5/4.0	22	70-1135-CAM0042	Bite Verification Cylinder 3.3 mm	17
70-1048-COM0019	Implant Analog (5/pk) 4.5/5.0	22	70-1135-CAM0044	Bite Verification Cylinder 3.8 mm	17
(Hiossen® HG System)					
70-1147-COM0016	Implant Analog (5/pk) Mini	26	70-1135-CAM0046	Bite Verification Cylinder 4.3 mm	17
70-1147-COM0017	Implant Analog (5/pk) Standard	26	70-1135-CAM0048	Bite Verification Cylinder 5.0 mm	17
(Inclusive® Tapered Implant System)					
70-1072-PRC0055	Implant Analog 3.0 mmP	6	70-1135-CAM0050	Bite Verification Cylinder 6.0 mm	17
70-1072-PRC0015	Implant Analog 3.5 mmP	6	70-1135-CAM0052	Bite Verification Cylinder, Non-Engag 3.3 mm	17
70-1072-PRC0017	Implant Analog 4.5 mmP	6	70-1135-CAM0054	Bite Verification Cylinder, Non-Engag 3.8 mm	17
(MegaGen AnyRidge® Implant System)					
70-1173-COM0002	Implant Analog (5/pk)	30	70-1135-CAM0056	Bite Verification Cylinder, Non-Engag 4.3 mm	17
(Nobel Biocare Brånemark System®)					
70-1049-COM0006	Implant Analog (5/pk) RP	33	70-1135-CAM0058	Bite Verification Cylinder, Non-Engag 5.0 mm	17
(NobelActive®)					
70-1050-COM0001	Implant Analog (5/pk) NP	35	70-1135-CAM0060	Bite Verification Cylinder, Non-Engag 6.0 mm	17
70-1050-COM0002	Implant Analog (5/pk) RP	35	(Dentsply Implants Ankylos® C/X)		
(NobelReplace®)					
70-1051-COM0109	Analog, Snappy Abutment 4.0 (5/pk) 6.0	38	70-1139-COM0049	Bite Verification Cylinder /X	20
70-1051-COM0111	Analog, Snappy Abutment 4.0 (5/pk) NP	38	70-1139-COM0048	Bite Verification Cylinder, Non-Engag C/	20
70-1051-COM0114	Analog, Snappy Abutment 4.0 (5/pk) RP	38	(DENTSPLY Implants ASTRA TECH Implant System®)		
70-1051-COM0117	Analog, Snappy Abutment 4.0 (5/pk) WP	38	70-1048-COM0133	Bite Verification Cylinder 3.0	22
70-1051-COM0120	Analog, Snappy Abutment 5.5 (5/pk) 6.0	38	70-1048-COM0134	Bite Verification Cylinder 3.5/4.0	22
70-1051-COM0123	Analog, Snappy Abutment 5.5 (5/pk) NP	38	70-1048-COM0135	Bite Verification Cylinder 4.5/5.0	22
70-1051-COM0126	Analog, Snappy Abutment 5.5 (5/pk) RP	38	70-1048-COM0131	Bite Verification Cylinder, Non-Engag 3.5/4.0	22
70-1051-COM0129	Analog, Snappy Abutment 5.5 (5/pk) WP	38	70-1048-COM0132	Bite Verification Cylinder, Non-Engag 4.5/5.0	22
70-1051-COM0001	Implant Analog (5/pk) 6.0	38	(Hiossen® HG System)		
70-1051-COM0002	Implant Analog (5/pk) NP	38	70-1147-COM0063	Bite Verification Cylinder Mini	26
70-1051-COM0003	Implant Analog (5/pk) RP	38	70-1147-COM0062	Bite Verification Cylinder Standard	26
70-1051-COM0004	Implant Analog (5/pk) WP	38	70-1147-COM0061	Bite Verification Cylinder, Non-Engag Mini	26
(Straumann® Bone Level)					
70-1052-COM0007	Implant Analog (5/pk) NC	43	70-1147-COM0060	Bite Verification Cylinder, Non-Engag Standard	26
70-1052-COM0008	Implant Analog (5/pk) RC	43	(MegaGen AnyRidge® Implant System)		
(Straumann® Tissue Level)					
70-1053-COM0020	Analog, Solid Abutment 14.3 mmL (5/pk) RN synOcta	46	70-1173-COM0015	Bite Verification Cylinder	30
70-1053-COM0023	Analog, Solid Abutment 15.8 mmL (5/pk) RN synOcta	46	70-1173-COM0014	Bite Verification Cylinder, Non-Engag	30
70-1053-COM0029	Analog, Solid Abutment 16 mmL (5/pk) WN synOcta	46	(Nobel Biocare Brånemark System®)		
70-1053-COM0026	Analog, Solid Abutment 17.3 mmL (5/pk) RN synOcta	46	70-1049-COM0047	Bite Verification Cylinder RP	33
70-1053-COM0032	Analog, Solid Abutment 17.5 mmL (5/pk) WN synOcta	46	70-1049-COM0044	Bite Verification Cylinder, Non-Engag RP	33
70-1053-COM0006	Implant Analog (5/pk) NN	46	(NobelActive®)		
70-1053-COM0007	Implant Analog (5/pk) RN synOcta	46	70-1050-COM0072	Bite Verification Cylinder NP	35
70-1053-COM0008	Implant Analog (5/pk) WN synOcta	46	70-1050-COM0073	Bite Verification Cylinder RP	35
(Zimmer Dental Screw-Vent®)					
70-1054-COM0010	Implant Analog (5/pk) 3.5 mm	48	70-1050-COM0070	Bite Verification Cylinder, Non-Engag NP	35
			70-1050-COM0071	Bite Verification Cylinder, Non-Engag RP	35
			(NobelReplace®)		
			70-1051-COM0170	Bite Verification Cylinder 6.0	39
			70-1051-COM0167	Bite Verification Cylinder NP	39
			70-1051-COM0168	Bite Verification Cylinder RP	39
			70-1051-COM0169	Bite Verification Cylinder WP	39
			70-1051-COM0166	Bite Verification Cylinder, Non-Engag 6.0	40
			70-1051-COM0163	Bite Verification Cylinder, Non-Engag NP	40
			70-1051-COM0164	Bite Verification Cylinder, Non-Engag RP	40
			70-1051-COM0165	Bite Verification Cylinder, Non-Engag WP	40
			(Straumann® Bone Level)		
			70-1052-COM0072	Bite Verification Cylinder NC	43
			70-1052-COM0073	Bite Verification Cylinder RC	43

Parts Index

CODE	DESCRIPTION	PAGE	CODE	DESCRIPTION	PAGE
70-1052-COM0070Bite Verification Cylinder, Non-Engag NC.....	43	70-1135-CAM013917° Multi-Unit Abutment 3 mmH 3.8 mm.....	19
70-1052-COM0071Bite Verification Cylinder, Non-Engag RC.....	43	70-1135-CAM014117° Multi-Unit Abutment 3 mmH 4.3 mm.....	19
(Straumann® Tissue Level)			70-1135-CAM014217° Multi-Unit Abutment 5 mmH 4.3 mm.....	19
70-1053-COM0049Bite Verification Cylinder RN synOcta®.....	46	70-1135-CAM014330° Multi-Unit Abutment 3 mmH 3.8 mm.....	19
70-1053-COM0050Bite Verification Cylinder WN synOcta®.....	46	70-1135-CAM014530° Multi-Unit Abutment 3 mmH 4.3 mm.....	19
70-1053-COM0047Bite Verification Cylinder, Non-Engag RN synOcta®.....	46	70-1135-CAM014430° Multi-Unit Abutment 5 mmH 3.8 mm.....	19
70-1053-COM0048Bite Verification Cylinder, Non-Engag WN synOcta®.....	46	70-1135-CAM014630° Multi-Unit Abutment 5 mmH 4.3 mm.....	19
(Zimmer Dental Screw-Vent®)			70-1135-CAM0147Angled Multi-Unit Abutment Screw 3.8/4.3 mm.....	19
70-1054-COM0097Bite Verification Cylinder 3.5 mm.....	48	70-1135-CAM0128Multi-Unit Abutment 1 mmH 3.8 mm.....	19
70-1054-COM0098Bite Verification Cylinder 4.5 mm.....	48	70-1135-CAM0131Multi-Unit Abutment 1 mmH 4.3 mm.....	19
70-1054-COM0099Bite Verification Cylinder 5.7 mm.....	48	70-1135-CAM0135Multi-Unit Abutment 1 mmH 5.0 mm.....	19
70-1054-COM0094Bite Verification Cylinder, Non-Engag 3.5 mm.....	48	70-1135-CAM0129Multi-Unit Abutment 2 mmH 3.8 mm.....	19
70-1054-COM0095Bite Verification Cylinder, Non-Engag 4.5 mm.....	48	70-1135-CAM0132Multi-Unit Abutment 2 mmH 4.3 mm.....	19
70-1054-COM0096Bite Verification Cylinder, Non-Engag 5.7 mm.....	48	70-1135-CAM0136Multi-Unit Abutment 2 mmH 5.0 mm.....	19
IMPRESSION TRANSFERS			70-1135-CAM0130Multi-Unit Abutment 3 mmH 3.8 mm.....	19
(Inclusive® Tapered Implant System)			70-1135-CAM0133Multi-Unit Abutment 3 mmH 4.3 mm.....	19
70-1072-PRC0051Transfer Coping, Closed-Tray, 3.0 mmP x 3.2 mmD.....	6	70-1135-CAM0137Multi-Unit Abutment 3 mmH 5.0 mm.....	19
70-1072-PRC0053Transfer Coping, Closed-Tray, 3.0 mmP x 3.7 mmD.....	6	70-1135-CAM0134Multi-Unit Abutment 5 mmH 4.3 mm.....	19
70-1072-PRC0007Transfer Coping, Closed-Tray, 3.5 mmP x 3.5 mmD.....	6	(Dentsply Implants Ankylos® C/X)		
70-1072-PRC0009Transfer Coping, Closed-Tray, 3.5 mmP x 4.7 mmD.....	6	70-1139-COM0001Multi-Unit Abutment 1.5 mmH /X.....	21
70-1072-PRC0011Transfer Coping, Closed-Tray, 4.5 mmP x 4.5 mmD.....	6	70-1139-COM0002Multi-Unit Abutment 2.5 mmH /X.....	21
70-1072-PRC0013Transfer Coping, Closed-Tray, 4.5 mmP x 5.7 mmD.....	6	70-1139-COM0003Multi-Unit Abutment 3.5 mmH /X.....	21
70-1072-PRC0052Transfer Coping, Open-Tray, 3.0 mmP x 3.2 mmD.....	6	70-1139-COM0004Multi-Unit Abutment 4.5 mmH /X.....	21
70-1072-PRC0054Transfer Coping, Open-Tray, 3.0 mmP x 3.7 mmD.....	6	(DENTSPLY Implants ASTRA TECH Implant System®)		
70-1072-PRC0006Transfer Coping, Open-Tray, 3.5 mmP x 3.5 mmD.....	6	70-1048-COM014317° Multi-Unit Abutment 2.5 mmH 3.5/4.0.....	25
70-1072-PRC0008Transfer Coping, Open-Tray, 3.5 mmP x 4.7 mmD.....	6	70-1048-COM014517° Multi-Unit Abutment 2.5 mmH 4.5/5.0.....	25
70-1072-PRC0010Transfer Coping, Open-Tray, 4.5 mmP x 4.5 mmD.....	6	70-1048-COM014417° Multi-Unit Abutment 3.5 mmH 3.5/4.0.....	25
70-1072-PRC0012Transfer Coping, Open-Tray, 4.5 mmP x 5.7 mmD.....	6	70-1048-COM014617° Multi-Unit Abutment 3.5 mmH 4.5/5.0.....	25
(NobelReplace®)			70-1048-COM014730° Multi-Unit Abutment 3.5 mmH 3.5/4.0.....	25
70-1051-COM0235Transfer Coping, Closed-Tray, NP.....	38	70-1048-COM014930° Multi-Unit Abutment 3.5 mmH 4.5/5.0.....	25
70-1051-COM0236Transfer Coping, Closed-Tray, RP.....	38	70-1048-COM014830° Multi-Unit Abutment 4.5 mmH 3.5/4.0.....	25
70-1051-COM0237Transfer Coping, Closed-Tray, WP.....	38	70-1048-COM015030° Multi-Unit Abutment 4.5 mmH 4.5/5.0.....	25
70-1051-COM0238Transfer Coping, Open-Tray, NP.....	38	70-1048-COM0151Angled Multi-Unit Abutment Screw 3.5/4.0.....	25
70-1051-COM0239Transfer Coping, Open-Tray, RP.....	38	70-1048-COM0152Angled Multi-Unit Abutment Screw 4.5/5.0.....	25
70-1051-COM0240Transfer Coping, Open-Tray, WP.....	38	70-1048-COM0136Multi-Unit Abutment 1.5 mmH 3.5/4.0.....	24
MULTI-UNIT ABUTMENTS			70-1048-COM0139Multi-Unit Abutment 1.5 mmH 4.5/5.0.....	24
(BIOMET 3i™ Certain®)			70-1048-COM0137Multi-Unit Abutment 2.5 mmH 3.5/4.0.....	24
70-1047-COM014417° Multi-Unit Abutment 2 mmH 3.4 mm.....	15	70-1048-COM0140Multi-Unit Abutment 2.5 mmH 4.5/5.0.....	24
70-1047-COM014617° Multi-Unit Abutment 2 mmH 4.1 mm.....	15	70-1048-COM0138Multi-Unit Abutment 3.5 mmH 3.5/4.0.....	24
70-1047-COM014817° Multi-Unit Abutment 2 mmH 5.0 mm.....	15	70-1048-COM0141Multi-Unit Abutment 3.5 mmH 4.5/5.0.....	24
70-1047-COM014517° Multi-Unit Abutment 3 mmH 3.4 mm.....	15	70-1048-COM0142Multi-Unit Abutment 4.5 mmH 4.5/5.0.....	24
70-1047-COM014717° Multi-Unit Abutment 3 mmH 4.1 mm.....	15	(Hiossen® HG System)		
70-1047-COM014917° Multi-Unit Abutment 3 mmH 5.0 mm.....	15	70-1147-COM007217° Multi-Unit Abutment 2.5 mmH Mini.....	28
70-1047-COM015030° Multi-Unit Abutment 4 mmH 4.1 mm.....	15	70-1147-COM007117° Multi-Unit Abutment 2.5 mmH Standard.....	28
70-1047-COM015130° Multi-Unit Abutment 5 mmH 4.1 mm.....	15	70-1147-COM007417° Multi-Unit Abutment 3.5 mmH Mini.....	28
70-1047-COM0152Angled Multi-Unit Abutment Screw 3.4/4.1/5.0/6.0 mm.....	15	70-1147-COM007317° Multi-Unit Abutment 3.5 mmH Standard.....	28
70-1047-COM0134Multi-Unit Abutment 1 mmH 3.4 mm.....	15	70-1147-COM007630° Multi-Unit Abutment 3.5 mmH Mini.....	28
70-1047-COM0137Multi-Unit Abutment 1 mmH 4.1 mm.....	15	70-1147-COM007530° Multi-Unit Abutment 3.5 mmH Standard.....	28
70-1047-COM0141Multi-Unit Abutment 1 mmH 5.0 mm.....	15	70-1147-COM007830° Multi-Unit Abutment 4.5 mmH Mini.....	28
70-1047-COM0135Multi-Unit Abutment 2 mmH 3.4 mm.....	15	70-1147-COM007730° Multi-Unit Abutment 4.5 mmH Standard.....	28
70-1047-COM0138Multi-Unit Abutment 2 mmH 4.1 mm.....	15	70-1147-COM0080Angled Multi-Unit Abutment Screw Mini.....	28
70-1047-COM0142Multi-Unit Abutment 2 mmH 5.0 mm.....	15	70-1147-COM0079Angled Multi-Unit Abutment Screw Standard.....	28
70-1047-COM0136Multi-Unit Abutment 3 mmH 3.4 mm.....	15	70-1147-COM0065Multi-Unit Abutment 1.5 mmH Mini.....	28
70-1047-COM0139Multi-Unit Abutment 3 mmH 4.1 mm.....	15	70-1147-COM0064Multi-Unit Abutment 1.5 mmH Standard.....	28
70-1047-COM0143Multi-Unit Abutment 3 mmH 5.0 mm.....	15	70-1147-COM0067Multi-Unit Abutment 2.5 mmH Mini.....	28
70-1047-COM0140Multi-Unit Abutment 5 mmH 4.1 mm.....	15	70-1147-COM0066Multi-Unit Abutment 2.5 mmH Standard.....	28
(CAMLOG® SCREW-LINE)			70-1147-COM0069Multi-Unit Abutment 3.5 mmH Mini.....	28
70-1135-CAM013817° Multi-Unit Abutment 2 mmH 3.8 mm.....	19	70-1147-COM0068Multi-Unit Abutment 3.5 mmH Standard.....	28
70-1135-CAM014017° Multi-Unit Abutment 2 mmH 4.3 mm.....	19	70-1147-COM0070Multi-Unit Abutment 4.5 mmH Standard.....	28
(Inclusive® Tapered Implant System)			70-1074-PRS000117° Multi-Unit Abutment 3.5 mmP x 2 mmH.....	10

Parts Index

CODE	DESCRIPTION	PAGE	CODE	DESCRIPTION	PAGE
70-1074-PRS000217° Multi-Unit Abutment 3.5 mmP x 3 mmH.....	10			
70-1074-PRS000317° Multi-Unit Abutment 4.5 mmP x 2 mmH.....	10			
70-1074-PRS000417° Multi-Unit Abutment 4.5 mmP x 3 mmH.....	10			
70-1074-PRS000517° Multi-Unit Abutment 4.5 mmP x 5 mmH.....	10			
70-1074-PRS000630° Multi-Unit Abutment 3.5 mmP x 3 mmH.....	10			
70-1074-PRS000730° Multi-Unit Abutment 4.5 mmP x 3 mmH.....	10			
70-1074-PRS000830° Multi-Unit Abutment 4.5 mmP x 5 mmH.....	10			
70-1074-PRS0031Angled Multi-Unit Abutment Screw.....	10			
70-1074-PRS0040Multi-Unit Abutment 3.0 mmP x 1.5 mmH.....	10			
70-1074-PRS0041Multi-Unit Abutment 3.0 mmP x 2.5 mmH.....	10			
70-1074-PRS0042Multi-Unit Abutment 3.0 mmP x 3.5 mmH.....	10			
70-1074-PRS0009Multi-Unit Abutment 3.5 mmP x 1 mmH.....	10			
70-1074-PRS0010Multi-Unit Abutment 3.5 mmP x 2 mmH.....	10			
70-1074-PRS0065Multi-Unit Abutment 3.5 mmP x 3 mmH.....	10			
70-1074-PRS0066Multi-Unit Abutment 3.5 mmP x 5 mmH.....	10			
70-1074-PRS0011Multi-Unit Abutment 4.5 mmP x 1 mmH.....	10			
70-1074-PRS0012Multi-Unit Abutment 4.5 mmP x 2 mmH.....	10			
70-1074-PRS0013Multi-Unit Abutment 4.5 mmP x 3 mmH.....	10			
70-1074-PRS0014Multi-Unit Abutment 4.5 mmP x 5 mmH.....	10			
(MegaGen AnyRidge® Implant System)					
70-1173-COM002717° Multi-Unit Abutment 3.5 mmH.....	31			
70-1173-COM002817° Multi-Unit Abutment 4.5 mmH.....	31			
70-1173-COM002917° Multi-Unit Abutment 5.5 mmH.....	31			
70-1173-COM003030° Multi-Unit Abutment 3.5 mmH.....	31			
70-1173-COM003130° Multi-Unit Abutment 4.5 mmH.....	31			
70-1173-COM003230° Multi-Unit Abutment 5.5 mmH.....	31			
70-1173-COM003330° Multi-Unit Abutment 6.5 mmH.....	31			
70-1173-COM0034Angled Multi-Unit Abutment Screw.....	31			
70-1173-COM0023Multi-Unit Abutment 2 mmH.....	31			
70-1173-COM0024Multi-Unit Abutment 3 mmH.....	31			
70-1173-COM0025Multi-Unit Abutment 4 mmH.....	31			
70-1173-COM0026Multi-Unit Abutment 5 mmH.....	31			
(Nobel Biocare Brånemark System®)					
70-1049-COM005317° Multi-Unit Abutment 2 mmH RP.....	34			
70-1049-COM005417° Multi-Unit Abutment 3 mmH RP.....	34			
70-1049-COM005517° Multi-Unit Abutment 4 mmH RP.....	34			
70-1049-COM005630° Multi-Unit Abutment 4 mmH RP.....	34			
70-1049-COM005730° Multi-Unit Abutment 5 mmH RP.....	34			
70-1049-COM0058Angled Multi-Unit Abutment Screw RP.....	34			
70-1049-COM0049Multi-Unit Abutment 1 mmH RP.....	34			
70-1049-COM0050Multi-Unit Abutment 2 mmH RP.....	34			
70-1049-COM0051Multi-Unit Abutment 3 mmH RP.....	34			
70-1049-COM0052Multi-Unit Abutment 5 mmH RP.....	34			
(NobelActive®)					
70-1050-COM008117° Multi-Unit Abutment 2.5 mmH NP.....	37			
70-1050-COM008317° Multi-Unit Abutment 2.5 mmH RP.....	37			
70-1050-COM008217° Multi-Unit Abutment 3.5 mmH NP.....	37			
70-1050-COM008417° Multi-Unit Abutment 3.5 mmH RP.....	37			
70-1050-COM008530° Multi-Unit Abutment 3.5 mmH NP.....	37			
70-1050-COM008730° Multi-Unit Abutment 3.5 mmH RP.....	37			
70-1050-COM008630° Multi-Unit Abutment 4.5 mmH NP.....	37			
70-1050-COM008830° Multi-Unit Abutment 4.5 mmH RP.....	37			
70-1050-COM0089Angled Multi-Unit Abutment Screw NP.....	37			
70-1050-COM0090Angled Multi-Unit Abutment Screw RP.....	37			
70-1050-COM0074Multi-Unit Abutment 1.5 mmH NP.....	37			
70-1050-COM0077Multi-Unit Abutment 1.5 mmH RP.....	37			
70-1050-COM0075Multi-Unit Abutment 2.5 mmH NP.....	37			
70-1050-COM0078Multi-Unit Abutment 2.5 mmH RP.....	37			
70-1050-COM0076Multi-Unit Abutment 3.5 mmH NP.....	37			
70-1050-COM0079Multi-Unit Abutment 3.5 mmH RP.....	37			
70-1050-COM0080Multi-Unit Abutment 4.5 mmH RP.....	37			
(NobelReplace®)					
70-1051-COM018117° Multi-Unit Abutment 2 mmH NP.....	42			
70-1051-COM018317° Multi-Unit Abutment 2 mmH RP.....	42			
70-1051-COM018217° Multi-Unit Abutment 3 mmH NP.....	42			
70-1051-COM018417° Multi-Unit Abutment 3 mmH RP.....	42			
70-1051-COM018517° Multi-Unit Abutment 4 mmH RP.....	42			
70-1051-COM018630° Multi-Unit Abutment 4 mmH RP.....	42			
70-1051-COM018730° Multi-Unit Abutment 5 mmH RP.....	42			
70-1051-COM0188Angled Multi-Unit Abutment Screw NP.....	42			
70-1051-COM0189Angled Multi-Unit Abutment Screw RP.....	42			
70-1051-COM0171Multi-Unit Abutment 1 mmH NP.....	42			
70-1051-COM0174Multi-Unit Abutment 1 mmH RP.....	42			
70-1051-COM0178Multi-Unit Abutment 1 mmH WP.....	42			
70-1051-COM0172Multi-Unit Abutment 2 mmH NP.....	42			
70-1051-COM0175Multi-Unit Abutment 2 mmH RP.....	42			
70-1051-COM0179Multi-Unit Abutment 2 mmH WP.....	42			
70-1051-COM0173Multi-Unit Abutment 3 mmH NP.....	42			
70-1051-COM0176Multi-Unit Abutment 3 mmH RP.....	42			
70-1051-COM0180Multi-Unit Abutment 3 mmH WP.....	42			
70-1051-COM0177Multi-Unit Abutment 5 mmH RP.....	42			
(Straumann® Bone Level)					
70-1052-COM008117° Multi-Unit Abutment 2.5 mmH NC.....	45			
70-1052-COM008317° Multi-Unit Abutment 2.5 mmH RC.....	45			
70-1052-COM008217° Multi-Unit Abutment 3.5 mmH NC.....	45			
70-1052-COM008417° Multi-Unit Abutment 3.5 mmH RC.....	45			
70-1052-COM008530° Multi-Unit Abutment 3.5 mmH RC.....	45			
70-1052-COM008630° Multi-Unit Abutment 4.5 mmH RC.....	45			
70-1052-COM0087Angled Multi-Unit Abutment Screw NC/RC.....	45			
70-1052-COM0074Multi-Unit Abutment 1.5 mmH NC.....	45			
70-1052-COM0077Multi-Unit Abutment 1.5 mmH RC.....	45			
70-1052-COM0075Multi-Unit Abutment 2.5 mmH NC.....	45			
70-1052-COM0078Multi-Unit Abutment 2.5 mmH RC.....	45			
70-1052-COM0076Multi-Unit Abutment 3.5 mmH NC.....	45			
70-1052-COM0079Multi-Unit Abutment 3.5 mmH RC.....	45			
70-1052-COM0080Multi-Unit Abutment 4.5 mmH RC.....	45			
(Straumann® Tissue Level)					
70-1053-COM0045Multi-Unit Abutment 1 mmH RN synOcta®.....	47			
70-1053-COM0046Multi-Unit Abutment 1.5 mmH WN synOcta®.....	47			
MULTI-UNIT ABUTMENT ACCESSORIES					
(Inclusive® Tapered Implant System)					
70-1074-PRS0016Multi-Unit Abutment Analog.....	11			
70-1074-PRS0048Multi-Unit Coping 4.5 mmH, Non-Engag - Unigrip.....	11			
70-1074-PRS0047Multi-Unit Coping 4.5 mmH, Non-Engag .048" Hex.....	11			
70-1073-PRA0037Multi-Unit Coping 4.5 mmH, Non-Engag .050" Hex.....	11			
70-1074-PRS0050Multi-Unit Coping 4.5 mmH, Non-Engag 1.0 mm.....	11			
70-1074-PRS0049Multi-Unit Coping 4.5 mmH, Non-Engag SCS.....	11			
70-1074-PRS0028Multi-Unit Driver.....	11			
70-1074-PRS0018Multi-Unit Gold Bar Coping.....	11			
70-1074-PRS0030Multi-Unit Gold/Plastic Coping.....	11			
70-1074-PRS0019Multi-Unit Guide Pin - Unigrip.....	11			
70-1074-PRS0035Multi-Unit Guide Pin .048" Hex.....	11			
70-1074-PRS0061Multi-Unit Guide Pin .050" Hex.....	11			
70-1074-PRS0036Multi-Unit Guide Pin 1.0 mm Hex.....	11			
70-1074-PRS0037Multi-Unit Guide Pin SCS.....	11			
70-1074-PRS0021Multi-Unit Impression Coping, Closed-Tray.....	11			
70-1074-PRS0022Multi-Unit Impression Coping, Open-Tray - Unigrip.....	11			
70-1074-PRS0053Multi-Unit Impression Coping, Open-Tray .048" Hex.....	11			
70-1074-PRS0052Multi-Unit Impression Coping, Open-Tray .050" Hex.....	11			
70-1074-PRS0055Multi-Unit Impression Coping, Open-Tray 1.0 mm Hex.....	11			
70-1074-PRS0054Multi-Unit Impression Coping, Open-Tray SCS.....	11			

Parts Index

CODE	DESCRIPTION	PAGE	CODE	DESCRIPTION	PAGE
70-1074-PRS0069	Multi-Unit Plastic Coping - Unigrip	11	70-1135-CAM0199	Laboratory Scanning Abutment, Blue (3/pk) 4.3 mm	16
70-1074-PRS0068	Multi-Unit Plastic Coping .048" Hex	11	70-1135-CAM0200	Laboratory Scanning Abutment, Blue (3/pk) 5.0 mm	16
70-1074-PRS0067	Multi-Unit Plastic Coping .050" Hex	11	70-1135-CAM0201	Laboratory Scanning Abutment, Blue (3/pk) 6.0 mm	16
70-1074-PRS0071	Multi-Unit Plastic Coping 1.0 mm Hex	11	(Dentsply Implants Ankylos® C/X)		
70-1074-PRS0070	Multi-Unit Plastic Coping SCS	11	70-1139-COM0040	Clinical Scanning Abutment, Anterior /X	20
70-1072-PRC0043	Multi-Unit Prosthetic Screw - Unigrip	11	70-1139-COM0039	Clinical Scanning Abutment, Posterior /X	20
70-1047-COM0153	Multi-Unit Prosthetic Screw .048" Hex	11	70-1139-COM0038	Laboratory Scanning Abutment (3/pk) /X	20
70-1072-PRC0014	Multi-Unit Prosthetic Screw .050" Hex	11	70-1139-COM0056	Laboratory Scanning Abutment, Blue (3/pk) /X	20
70-1072-PRC0046	Multi-Unit Prosthetic Screw 1.0 mm Hex	11	(DENTSPLY Implants ASTRA TECH Implant System®)		
70-1052-COM0088	Multi-Unit Prosthetic Screw SCS	11	70-1048-COM0124	Clinical Scanning Abutment, Anterior 3.0	22
70-1074-PRS0044	Multi-Unit Temporary Healing Cap - Unigrip	11	70-1048-COM0125	Clinical Scanning Abutment, Anterior 3.5/4.0	22
70-1074-PRS0043	Multi-Unit Temporary Healing Cap .048" Hex	11	70-1048-COM0126	Clinical Scanning Abutment, Anterior 4.5/5.0	22
70-1074-PRS0015	Multi-Unit Temporary Healing Cap .050" Hex	11	70-1048-COM0179	Clinical Scanning Abutment, Posterior 3.0	22
70-1074-PRS0046	Multi-Unit Temporary Healing Cap 1.0 mm Hex	11	70-1048-COM0180	Clinical Scanning Abutment, Posterior 3.5/4.0	22
70-1074-PRS0045	Multi-Unit Temporary Healing Cap SCS	11	70-1048-COM0181	Clinical Scanning Abutment, Posterior 4.5/5.0	22
70-1074-PRS0057	Multi-Unit Titanium Temporary - Unigrip	11	70-1048-COM0173	Laboratory Scanning Abutment (3/pk) 3.0	22
70-1074-PRS0056	Multi-Unit Titanium Temporary .048" Hex	11	70-1048-COM0174	Laboratory Scanning Abutment (3/pk) 3.5/4.0	22
70-1074-PRS0025	Multi-Unit Titanium Temporary .050" Hex	11	70-1048-COM0175	Laboratory Scanning Abutment (3/pk) 4.5/5.0	22
70-1074-PRS0059	Multi-Unit Titanium Temporary 1.0 mm Hex	11	70-1048-COM0188	Laboratory Scanning Abutment, Blue (3/pk) 3.0	22
70-1074-PRS0058	Multi-Unit Titanium Temporary SCS	11	70-1048-COM0189	Laboratory Scanning Abutment, Blue (3/pk) 3.5/4.0	22
PROSTHETIC KIT			70-1048-COM0190	Laboratory Scanning Abutment, Blue (3/pk) 4.5/5.0	22
(Inclusive® Tapered Implant System)			(Hiossen® HG System)		
70-1071-PRS0001	Inclusive® Tapered Implant Prosthetic Kit	50	70-1147-COM0039	Clinical Scanning Abutment, Anterior Mini	26
SCANNING ABUTMENTS			70-1147-COM0038	Clinical Scanning Abutment, Anterior Standard	26
(BIOMET 3i™ Certain®)			70-1147-COM0041	Clinical Scanning Abutment, Posterior Mini	26
70-1047-COM0118	Clinical Scanning Abutment, Anterior 3.4 mm	12	70-1147-COM0040	Clinical Scanning Abutment, Posterior Standard	26
70-1047-COM0119	Clinical Scanning Abutment, Anterior 4.1 mm	12	70-1147-COM0023	Laboratory Scanning Abutment (3/pk) Mini	26
70-1047-COM0120	Clinical Scanning Abutment, Anterior 5.0 mm	12	70-1147-COM0022	Laboratory Scanning Abutment (3/pk) Standard	26
70-1047-COM0121	Clinical Scanning Abutment, Anterior 6.0 mm	12	70-1147-COM0025	Laboratory Scanning Abutment, Blue (3/pk) Mini	26
70-1047-COM0187	Clinical Scanning Abutment, Posterior 3.4 mm	12	70-1147-COM0024	Laboratory Scanning Abutment, Blue (3/pk) Standard	26
70-1047-COM0188	Clinical Scanning Abutment, Posterior 4.1 mm	12	(Inclusive® Tapered Implant System)		
70-1047-COM0189	Clinical Scanning Abutment, Posterior 5.0 mm	12	70-1073-PRA0051	Clinical Scanning Abutment, Anterior, 3.0 mmP	6
70-1047-COM0190	Clinical Scanning Abutment, Posterior 6.0 mm	12	70-1073-PRA0042	Clinical Scanning Abutment, Anterior, 3.5 mmP	6
70-1047-COM0175	Laboratory Scanning Abutment (3/pk) 3.4 mm	12	70-1073-PRA0043	Clinical Scanning Abutment, Anterior, 4.5 mmP	6
70-1047-COM0176	Laboratory Scanning Abutment (3/pk) 4.1 mm	12	70-1073-PRA0050	Clinical Scanning Abutment, Posterior, 3.0 mmP	7
70-1047-COM0177	Laboratory Scanning Abutment (3/pk) 5.0 mm	12	70-1073-PRA0040	Clinical Scanning Abutment, Posterior, 3.5 mmP	7
70-1047-COM0178	Laboratory Scanning Abutment (3/pk) 6.0 mm	12	70-1073-PRA0041	Clinical Scanning Abutment, Posterior, 4.5 mmP	7
70-1047-COM0200	Laboratory Scanning Abutment, Blue (3/pk) 3.4 mm	12	70-1073-PRA0049	Laboratory Scanning Abutment 3.0 mmP (3/pk)	7
70-1047-COM0201	Laboratory Scanning Abutment, Blue (3/pk) 4.1 mm	12	70-1073-PRA0033	Laboratory Scanning Abutment 3.5 mmP (3/pk)	7
70-1047-COM0202	Laboratory Scanning Abutment, Blue (3/pk) 5.0 mm	12	70-1073-PRA0034	Laboratory Scanning Abutment 4.5 mmP (3/pk)	7
70-1047-COM0203	Laboratory Scanning Abutment, Blue (3/pk) 6.0 mm	12	70-1073-PRA0061	Laboratory Scanning Abutment Kit Blue	51
(CAMLOG® SCREW-LINE)			70-1073-PRA0039	Laboratory Scanning Abutment Kit Red	51
70-1135-CAM0092	Clinical Scanning Abutment, Anterior 3.3 mm	16	70-1073-PRA0066	Laboratory Scanning Abutment, Blue, 3.0 mmP (3/pk)	7
70-1135-CAM0093	Clinical Scanning Abutment, Anterior 3.8 mm	16	70-1073-PRA0067	Laboratory Scanning Abutment, Blue, 3.5 mmP (3/pk)	7
70-1135-CAM0094	Clinical Scanning Abutment, Anterior 4.3 mm	16	70-1073-PRA0068	Laboratory Scanning Abutment, Blue, 4.5 mmP (3/pk)	7
70-1135-CAM0095	Clinical Scanning Abutment, Anterior 5.0 mm	16	(Keystone Dental PrimaConnex®)		
70-1135-CAM0096	Clinical Scanning Abutment, Anterior 6.0 mm	16	70-1055-COM0018	Clinical Scanning Abutment, Anterior RD	29
70-1135-CAM0182	Clinical Scanning Abutment, Posterior 3.3 mm	16	70-1055-COM0017	Clinical Scanning Abutment, Anterior SD	29
70-1135-CAM0183	Clinical Scanning Abutment, Posterior 3.8 mm	16	70-1055-COM0019	Clinical Scanning Abutment, Anterior WD	29
70-1135-CAM0184	Clinical Scanning Abutment, Posterior 4.3 mm	16	70-1055-COM0036	Clinical Scanning Abutment, Posterior RD	29
70-1135-CAM0185	Clinical Scanning Abutment, Posterior 5.0 mm	16	70-1055-COM0035	Clinical Scanning Abutment, Posterior SD	29
70-1135-CAM0186	Clinical Scanning Abutment, Posterior 6.0 mm	16	70-1055-COM0037	Clinical Scanning Abutment, Posterior WD	29
70-1135-CAM0172	Laboratory Scanning Abutment (3/pk) 3.3 mm	16	70-1055-COM0030	Laboratory Scanning Abutment (3/pk) RD	29
70-1135-CAM0173	Laboratory Scanning Abutment (3/pk) 3.8 mm	16	70-1055-COM0029	Laboratory Scanning Abutment (3/pk) SD	29
70-1135-CAM0174	Laboratory Scanning Abutment (3/pk) 4.3 mm	16	70-1055-COM0031	Laboratory Scanning Abutment (3/pk) WD	29
70-1135-CAM0175	Laboratory Scanning Abutment (3/pk) 5.0 mm	16	70-1055-COM0045	Laboratory Scanning Abutment, Blue (3/pk) RD	29
70-1135-CAM0176	Laboratory Scanning Abutment (3/pk) 6.0 mm	16	70-1055-COM0044	Laboratory Scanning Abutment, Blue (3/pk) SD	29
70-1135-CAM0197	Laboratory Scanning Abutment, Blue (3/pk) 3.3 mm	16	70-1055-COM0046	Laboratory Scanning Abutment, Blue (3/pk) WD	29
70-1135-CAM0198	Laboratory Scanning Abutment, Blue (3/pk) 3.8 mm	16	(MegaGen AnyRidge® Implant System)		
			70-1173-COM0009	Clinical Scanning Abutment, Anterior	30
			70-1173-COM0008	Clinical Scanning Abutment, Posterior	30

Parts Index

CODE	DESCRIPTION	PAGE	CODE	DESCRIPTION	PAGE
70-1173-COM0006	Laboratory Scanning Abutment (3/pk)	30	70-1054-COM0106	Laboratory Scanning Abutment (3/pk) 3.5 mm	48
70-1173-COM0007	Laboratory Scanning Abutment, Blue (3/pk)	30	70-1054-COM0107	Laboratory Scanning Abutment (3/pk) 4.5 mm	48
(Neoss Implant System®)			70-1054-COM0108	Laboratory Scanning Abutment (3/pk) 5.7 mm	48
70-1056-COM0006	Clinical Scanning Abutment, Anterior 4.0 mm	32	70-1054-COM0151	Laboratory Scanning Abutment, Blue (3/pk) 3.5 mm	48
70-1056-COM0012	Clinical Scanning Abutment, Posterior 4.0 mm	32	70-1054-COM0152	Laboratory Scanning Abutment, Blue (3/pk) 4.5 mm	48
70-1056-COM0010	Laboratory Scanning Abutment (3/pk) 4.0 mm	32	70-1054-COM0153	Laboratory Scanning Abutment, Blue (3/pk) 5.7 mm	48
70-1056-COM0015	Laboratory Scanning Abutment, Blue (3/pk) 4.0 mm	32	TEMPORARY ABUTMENTS		
(Nobel Biocare Brånemark System®)			(Inclusive® Tapered Implant System)		
70-1049-COM0041	Clinical Scanning Abutment, Anterior RP	33	70-1073-PRA0048	Temporary Abutment 3.0 mmP	7
70-1049-COM0067	Clinical Scanning Abutment, Posterior RP	33	70-1073-PRA0022	Temporary Abutment 3.5 mmP	7
70-1049-COM0065	Laboratory Scanning Abutment (3/pk) RP	33	70-1073-PRA0024	Temporary Abutment 4.5 mmP	7
70-1049-COM0072	Laboratory Scanning Abutment, Blue (3/pk) RP	33	70-1073-PRA0047	Temporary Abutment, Non-Engag, 3.0 mmP	7
(NobelActive®)			70-1073-PRA0023	Temporary Abutment, Non-Engag, 3.5 mmP	7
70-1050-COM0066	Clinical Scanning Abutment, Anterior NP	35	70-1073-PRA0025	Temporary Abutment, Non-Engag, 4.5 mmP	7
70-1050-COM0067	Clinical Scanning Abutment, Anterior RP	35	TITANIUM ABUTMENT BLANKS		
70-1050-COM0109	Clinical Scanning Abutment, Posterior NP	35	(BIOMET 3i™ Certain®)		
70-1050-COM0110	Clinical Scanning Abutment, Posterior RP	35	70-1047-COM0054	Titanium Abutment Blank 3.4 mm	14
70-1050-COM0105	Laboratory Scanning Abutment (3/pk) NP	35	70-1047-COM0055	Titanium Abutment Blank 4.1 mm	14
70-1050-COM0106	Laboratory Scanning Abutment (3/pk) RP	35	70-1047-COM0056	Titanium Abutment Blank 5.0 mm	14
70-1050-COM0135	Laboratory Scanning Abutment, Blue (3/pk) NP	35	70-1047-COM0057	Titanium Abutment Blank 6.0 mm	14
70-1050-COM0136	Laboratory Scanning Abutment, Blue (3/pk) RP	35	(CAMLOG® SCREW-LINE)		
(NobelReplace®)			70-1135-CAM0117	Titanium Abutment Blank 3.3 mm	18
70-1051-COM0158	Clinical Scanning Abutment, Anterior 6.0	39	70-1135-CAM0118	Titanium Abutment Blank 3.8 mm	18
70-1051-COM0155	Clinical Scanning Abutment, Anterior NP	39	70-1135-CAM0119	Titanium Abutment Blank 4.3 mm	18
70-1051-COM0156	Clinical Scanning Abutment, Anterior RP	39	70-1135-CAM0120	Titanium Abutment Blank 5.0 mm	18
70-1051-COM0157	Clinical Scanning Abutment, Anterior WP	39	70-1135-CAM0121	Titanium Abutment Blank 6.0 mm	18
70-1051-COM0232	Clinical Scanning Abutment, Posterior 6.0	39	(DENTSPLY Implants ASTRA TECH Implant System®)		
70-1051-COM0229	Clinical Scanning Abutment, Posterior NP	39	70-1048-COM0064	Titanium Abutment Blank 3.0	23
70-1051-COM0230	Clinical Scanning Abutment, Posterior RP	39	70-1048-COM0065	Titanium Abutment Blank 3.5/4.0	23
70-1051-COM0231	Clinical Scanning Abutment, Posterior WP	39	70-1048-COM0066	Titanium Abutment Blank 4.5/5.0	23
70-1051-COM0218	Laboratory Scanning Abutment (3/pk) 6.0	39	(Nobel Biocare Brånemark System®)		
70-1051-COM0215	Laboratory Scanning Abutment (3/pk) NP	39	70-1049-COM0016	Titanium Abutment Blank RP	33
70-1051-COM0216	Laboratory Scanning Abutment (3/pk) RP	39	(NobelActive®)		
70-1051-COM0217	Laboratory Scanning Abutment (3/pk) WP	39	70-1050-COM0029	Titanium Abutment Blank NP	36
70-1051-COM0260	Laboratory Scanning Abutment, Blue (3/pk) 6.0	39	70-1050-COM0030	Titanium Abutment Blank RP	36
70-1051-COM0257	Laboratory Scanning Abutment, Blue (3/pk) NP	39	(NobelReplace®)		
70-1051-COM0258	Laboratory Scanning Abutment, Blue (3/pk) RP	39	70-1051-COM0055	Titanium Abutment Blank 6.0	41
70-1051-COM0259	Laboratory Scanning Abutment, Blue (3/pk) WP	39	70-1051-COM0056	Titanium Abutment Blank NP	41
(Straumann® Bone Level)			70-1051-COM0057	Titanium Abutment Blank RP	41
70-1052-COM0066	Clinical Scanning Abutment, Anterior NC	43	70-1051-COM0058	Titanium Abutment Blank WP	41
70-1052-COM0067	Clinical Scanning Abutment, Anterior RC	43	(Straumann® Bone Level)		
70-1052-COM0109	Clinical Scanning Abutment, Posterior NC	43	70-1052-COM0030	Titanium Abutment Blank NC	44
70-1052-COM0110	Clinical Scanning Abutment, Posterior RC	43	70-1052-COM0031	Titanium Abutment Blank RC	44
70-1052-COM0101	Laboratory Scanning Abutment (3/pk) NC	43	(Zimmer Dental Screw-Vent®)		
70-1052-COM0102	Laboratory Scanning Abutment (3/pk) RC	43	70-1054-COM0041	Titanium Abutment Blank 3.5 mm	49
70-1052-COM0135	Laboratory Scanning Abutment, Blue (3/pk) NC	43	70-1054-COM0042	Titanium Abutment Blank 4.5 mm	49
70-1052-COM0136	Laboratory Scanning Abutment, Blue (3/pk) RC	43	70-1054-COM0043	Titanium Abutment Blank 5.7 mm	49
(Straumann® Tissue Level)			TITANIUM ABUTMENTS		
70-1053-COM0043	Clinical Scanning Abutment, Posterior RN synOcta	46	(BIOMET 3i™ Certain®)		
70-1053-COM0044	Clinical Scanning Abutment, Posterior WN synOcta	46	70-1047-COM0084	Titanium Abutment 4.5 mmH 3.4 mm	13
70-1053-COM0041	Laboratory Scanning Abutment (3/pk) RN synOcta	46	70-1047-COM0086	Titanium Abutment 4.5 mmH 4.1 mm	13
70-1053-COM0042	Laboratory Scanning Abutment (3/pk) WN synOcta	46	70-1047-COM0088	Titanium Abutment 4.5 mmH 5.0 mm	13
70-1053-COM0087	Laboratory Scanning Abutment, Blue (3/pk) RN synOcta	46	70-1047-COM0090	Titanium Abutment 4.5 mmH 6.0 mm	13
70-1053-COM0088	Laboratory Scanning Abutment, Blue (3/pk) WN synOcta	46	70-1047-COM0092	Titanium Abutment 4.5 mmH, Non-Engag, 3.4 mm	13
(Zimmer Dental Screw-Vent®)			70-1047-COM0094	Titanium Abutment 4.5 mmH, Non-Engag, 4.1 mm	13
70-1054-COM0088	Clinical Scanning Abutment, Anterior 3.5 mm	48	70-1047-COM0096	Titanium Abutment 4.5 mmH, Non-Engag, 5.0 mm	13
70-1054-COM0089	Clinical Scanning Abutment, Anterior 4.5 mm	48	70-1047-COM0098	Titanium Abutment 4.5 mmH, Non-Engag, 6.0 mm	13
70-1054-COM0090	Clinical Scanning Abutment, Anterior 5.7 mm	48	70-1047-COM0005	Titanium Abutment 6 mmH 3.4 mm	13
70-1054-COM0115	Clinical Scanning Abutment, Posterior 3.5 mm	48			
70-1054-COM0116	Clinical Scanning Abutment, Posterior 4.5 mm	48			
70-1054-COM0117	Clinical Scanning Abutment, Posterior 5.7 mm	48			

Parts Index

CODE	DESCRIPTION	PAGE	CODE	DESCRIPTION	PAGE
70-1047-COM0006Titanium Abutment 6 mmH 4.1 mm	13	70-1050-COM0052Titanium Abutment 4.5 mmH, Non-Engag, RP	35
70-1047-COM0007Titanium Abutment 6 mmH 5.0 mm	13	70-1050-COM0021Titanium Abutment 6 mmH NP	35
70-1047-COM0008Titanium Abutment 6 mmH 6.0 mm	13	70-1050-COM0022Titanium Abutment 6 mmH RP	35
(CAMLOG® SCREW-LINE)			(NobelReplace®)		
70-1135-CAM0012Titanium Abutment 4.5 mmH 3.3 mm	17	70-1051-COM0088Titanium Abutment 4.5 mmH 6.0	40
70-1135-CAM0014Titanium Abutment 4.5 mmH 3.8 mm	17	70-1051-COM0090Titanium Abutment 4.5 mmH NP	40
70-1135-CAM0016Titanium Abutment 4.5 mmH 4.3 mm	17	70-1051-COM0092Titanium Abutment 4.5 mmH RP	40
70-1135-CAM0018Titanium Abutment 4.5 mmH 5.0 mm	17	70-1051-COM0094Titanium Abutment 4.5 mmH WP	40
70-1135-CAM0020Titanium Abutment 4.5 mmH 6.0 mm	17	70-1051-COM0096Titanium Abutment 4.5 mmH, Non-Engag, 6.0	40
70-1135-CAM0022Titanium Abutment 4.5 mmH, Non-Engag, 3.3 mm	17	70-1051-COM0098Titanium Abutment 4.5 mmH, Non-Engag, NP	40
70-1135-CAM0024Titanium Abutment 4.5 mmH, Non-Engag, 3.8 mm	17	70-1051-COM0100Titanium Abutment 4.5 mmH, Non-Engag, RP	40
70-1135-CAM0026Titanium Abutment 4.5 mmH, Non-Engag, 4.3 mm	17	70-1051-COM0102Titanium Abutment 4.5 mmH, Non-Engag, WP	40
70-1135-CAM0028Titanium Abutment 4.5 mmH, Non-Engag, 5.0 mm	17	70-1051-COM0047Titanium Abutment 6 mmH 6.0	40
70-1135-CAM0030Titanium Abutment 4.5 mmH, Non-Engag, 6.0 mm	17	70-1051-COM0048Titanium Abutment 6 mmH NP	40
70-1135-CAM0032Titanium Abutment 6 mmH 3.3 mm	17	70-1051-COM0049Titanium Abutment 6 mmH RP	40
70-1135-CAM0034Titanium Abutment 6 mmH 3.8 mm	17	70-1051-COM0050Titanium Abutment 6 mmH WP	40
70-1135-CAM0036Titanium Abutment 6 mmH 4.3 mm	17	(Straumann® Bone Level)		
70-1135-CAM0038Titanium Abutment 6 mmH 5.0 mm	17	70-1052-COM0045Titanium Abutment 4.5 mmH NC	43
70-1135-CAM0040Titanium Abutment 6 mmH 6.0 mm	17	70-1052-COM0047Titanium Abutment 4.5 mmH RC	43
(Dentsply Implants Ankylos® C/X)			70-1052-COM0049Titanium Abutment 4.5 mmH, Non-Engag, NC	44
70-1139-COM0045Titanium Abutment 4.5 mmH /X 3.5 A	20	70-1052-COM0051Titanium Abutment 4.5 mmH, Non-Engag, RC	44
70-1139-COM0041Titanium Abutment 4.5 mmH, Non-Engag, C/ 3.5 A	20	70-1052-COM0003Titanium Abutment 6 mmH NC	43
70-1139-COM0042Titanium Abutment 4.5 mmH, Non-Engag, C/ 4.5 B	20	70-1052-COM0004Titanium Abutment 6 mmH RC	43
70-1139-COM0043Titanium Abutment 4.5 mmH, Non-Engag, C/ 5.5 C	20	(Straumann® Tissue Level)		
70-1139-COM0046Titanium Abutment 6 mmH /X 3.5 A	20	70-1053-COM0059Titanium Abutment 4.5 mmH RN synOcta®	47
(DENTSPLY Implants ASTRA TECH Implant System®)			70-1053-COM0060Titanium Abutment 4.5 mmH WN synOcta®	47
70-1048-COM0089Titanium Abutment 4.5 mmH 3.0	23	70-1053-COM0057Titanium Abutment 4.5 mmH, Non-Engag, RN synOcta	47
70-1048-COM0091Titanium Abutment 4.5 mmH 3.5/4.0	23	70-1053-COM0058Titanium Abutment 4.5 mmH, Non-Engag, WN synOcta	47
70-1048-COM0093Titanium Abutment 4.5 mmH 4.5/5.0	23	70-1053-COM0061Titanium Abutment 6 mmH RN synOcta®	47
70-1048-COM0097Titanium Abutment 4.5 mmH, Non-Engag, 3.5/4.0	23	70-1053-COM0062Titanium Abutment 6 mmH WN synOcta®	47
70-1048-COM0099Titanium Abutment 4.5 mmH, Non-Engag, 4.5/5.0	23	(Zimmer Dental Screw-Vent®)		
70-1048-COM0004Titanium Abutment 6 mmH 3.0	23	70-1054-COM0063Titanium Abutment 4.5 mmH 3.5 mm	49
70-1048-COM0005Titanium Abutment 6 mmH 3.5/4.0	23	70-1054-COM0065Titanium Abutment 4.5 mmH 4.5 mm	49
70-1048-COM0006Titanium Abutment 6 mmH 4.5/5.0	23	70-1054-COM0067Titanium Abutment 4.5 mmH 5.7 mm	49
(Hiossen® HG System)			70-1054-COM0069Titanium Abutment 4.5 mmH, Non-Engag, 3.5 mm	49
70-1147-COM0043Titanium Abutment 4.5 mmH Mini	26	70-1054-COM0071Titanium Abutment 4.5 mmH, Non-Engag, 4.5 mm	49
70-1147-COM0042Titanium Abutment 4.5 mmH Standard	26	70-1054-COM0073Titanium Abutment 4.5 mmH, Non-Engag, 5.7 mm	49
70-1147-COM0045Titanium Abutment 4.5 mmH, Non-Engag, Mini	26	70-1054-COM0004Titanium Abutment 6 mmH 3.5 mm	49
70-1147-COM0044Titanium Abutment 4.5 mmH, Non-Engag, Standard	26	70-1054-COM0005Titanium Abutment 6 mmH 4.5 mm	49
70-1147-COM0047Titanium Abutment 6 mmH Mini	27	70-1054-COM0006Titanium Abutment 6 mmH 5.7 mm	49
70-1147-COM0046Titanium Abutment 6 mmH Standard	27	TITANIUM ESTHETIC ABUTMENTS		
(Inclusive® Tapered Implant System)			(BIOMET 3i™ Certain®)		
70-1073-PRA0052Titanium Abutment 3.0 mmP x 4.5 mmH	8	70-1047-COM015415° Ti. Esthetic Abut., Anterior 3.4 mm	13
70-1073-PRA0053Titanium Abutment 3.0 mmP x 6 mmH	8	70-1047-COM015515° Ti. Esthetic Abut., Anterior 4.1 mm	13
70-1073-PRA0045Titanium Abutment 3.5 mmP x 4.5 mmH	8	70-1047-COM015615° Ti. Esthetic Abut., Anterior 5.0 mm	13
70-1073-PRA0006Titanium Abutment 3.5 mmP x 6 mmH	8	70-1047-COM015715° Ti. Esthetic Abut., Posterior 4.1 mm	13
70-1073-PRA0046Titanium Abutment 4.5 mmP x 4.5 mmH	8	70-1047-COM015815° Ti. Esthetic Abut., Posterior 5.0 mm	13
70-1073-PRA0008Titanium Abutment 4.5 mmP x 6 mmH	8	70-1047-COM0159Ti. Esthetic Abut., Anterior 3.4 mm	14
(MegaGen AnyRidge® Implant System)			70-1047-COM0160Ti. Esthetic Abut., Anterior 4.1 mm	14
70-1173-COM0012Titanium Abutment 4.5 mmH	30	70-1047-COM0161Ti. Esthetic Abut., Anterior 5.0 mm	14
70-1173-COM0010Titanium Abutment 4.5 mmH, Non-Engag, Ø3.5	30	70-1047-COM0162Ti. Esthetic Abut., Posterior 4.1 mm	14
70-1173-COM0011Titanium Abutment 4.5 mmH, Non-Engag, Ø5.0	30	70-1047-COM0163Ti. Esthetic Abut., Posterior 5.0 mm	14
70-1173-COM0013Titanium Abutment 6 mmH	30	70-1047-COM0164Ti. Esthetic Abut., Posterior 6.0 mm	14
(Nobel Biocare Brånemark System®)			(CAMLOG® SCREW-LINE)		
70-1049-COM0024Titanium Abutment 4.5 mmH RP	33	70-1135-CAM014815° Ti. Esthetic Abut., Anterior 3.3 mm	18
70-1049-COM0026Titanium Abutment 4.5 mmH, Non-Engag, RP	33	70-1135-CAM014915° Ti. Esthetic Abut., Anterior 3.8 mm	18
70-1049-COM0002Titanium Abutment 6 mmH RP	33	70-1135-CAM015015° Ti. Esthetic Abut., Anterior 4.3 mm	18
(NobelActive®)			70-1135-CAM015115° Ti. Esthetic Abut., Posterior 4.3 mm	18
70-1050-COM0046Titanium Abutment 4.5 mmH NP	35	70-1135-CAM015215° Ti. Esthetic Abut., Posterior 5.0 mm	18
70-1050-COM0048Titanium Abutment 4.5 mmH RP	35	70-1135-CAM0153Ti. Esthetic Abut., Anterior 3.3 mm	18
70-1050-COM0050Titanium Abutment 4.5 mmH, Non-Engag, NP	35			

Parts Index

CODE	DESCRIPTION	PAGE	CODE	DESCRIPTION	PAGE
70-1135-CAM0154Ti. Esthetic Abut., Anterior 3.8 mm	18	70-1051-COM019315° Ti. Esthetic Abut., Posterior RP	40
70-1135-CAM0155Ti. Esthetic Abut., Anterior 4.3 mm	18	70-1051-COM019415° Ti. Esthetic Abut., Posterior WP	40
70-1135-CAM0156Ti. Esthetic Abut., Posterior 4.3 mm	18	70-1051-COM0195Ti. Esthetic Abut., Anterior NP	40
70-1135-CAM0157Ti. Esthetic Abut., Posterior 5.0 mm	18	70-1051-COM0196Ti. Esthetic Abut., Anterior RP	40
(Dentsply Implants Ankylos® C/X)			70-1051-COM0197Ti. Esthetic Abut., Anterior WP	40
70-1139-COM005215° Ti. Esthetic Abut., Anterior /X	21	70-1051-COM0200Ti. Esthetic Abut., Posterior 6.0	40
70-1139-COM005315° Ti. Esthetic Abut., Posterior /X	21	70-1051-COM0198Ti. Esthetic Abut., Posterior RP	40
70-1139-COM0050Ti. Esthetic Abut., Anterior /X	21	70-1051-COM0199Ti. Esthetic Abut., Posterior WP	40
70-1139-COM0051Ti. Esthetic Abut., Posterior /X	21	(Straumann® Bone Level)		
(DENTSPLY Implants ASTRA TECH Implant System®)			70-1052-COM008915° Ti. Esthetic Abut., Anterior NC	44
70-1048-COM015315° Ti. Esthetic Abut., Anterior 3.0	23	70-1052-COM009015° Ti. Esthetic Abut., Anterior RC	44
70-1048-COM015415° Ti. Esthetic Abut., Anterior 3.5/4.0	23	70-1052-COM009115° Ti. Esthetic Abut., Posterior RC	44
70-1048-COM015515° Ti. Esthetic Abut., Anterior 4.5/5.0	23	70-1052-COM0092Ti. Esthetic Abut., Anterior NC	44
70-1048-COM015615° Ti. Esthetic Abut., Posterior 3.5/4.0	23	70-1052-COM0093Ti. Esthetic Abut., Anterior RC	44
70-1048-COM015715° Ti. Esthetic Abut., Posterior 4.5/5.0	23	70-1052-COM0094Ti. Esthetic Abut., Posterior RC	44
70-1048-COM0158Ti. Esthetic Abut., Anterior 3.0	23	TITANIUM SCREWS AND GUIDE PINS		
70-1048-COM0159Ti. Esthetic Abut., Anterior 3.5/4.0	23	(BIOMET 3i™ Certain®)		
70-1048-COM0160Ti. Esthetic Abut., Anterior 4.5/5.0	23	70-1047-COM0112Guide Pin (5/pk) 3.4/4.1/5.0/6.0 mm	14
70-1048-COM0161Ti. Esthetic Abut., Posterior 3.5/4.0	23	70-1047-COM0029Titanium Screw (5/pk) 3.4/4.1/5.0/6.0 mm	14
70-1048-COM0162Ti. Esthetic Abut., Posterior 4.5/5.0	23	70-1047-COM0117Titanium Screw 3.4/4.1/5.0/6.0 mm	14
(Hiossen® HG System)			(CAMLOG® SCREW-LINE)		
70-1147-COM005315° Ti. Esthetic Abut., Anterior Mini	27	70-1135-CAM0064Guide Pin (5/pk) 3.3/3.8/4.3 mm	19
70-1147-COM005215° Ti. Esthetic Abut., Anterior Standard	27	70-1135-CAM0066Guide Pin (5/pk) 5.0/6.0 mm	19
70-1147-COM005515° Ti. Esthetic Abut., Posterior Mini	27	70-1135-CAM0125Titanium Screw (5/pk) 3.3/3.8/4.3 mm	18
70-1147-COM005415° Ti. Esthetic Abut., Posterior Standard	27	70-1135-CAM0127Titanium Screw (5/pk) 5.0/6.0 mm	18
70-1147-COM0049Ti. Esthetic Abut., Anterior Mini	27	70-1135-CAM0124Titanium Screw 3.3/3.8/4.3 mm	18
70-1147-COM0048Ti. Esthetic Abut., Anterior Standard	27	70-1135-CAM0126Titanium Screw 5.0/6.0 mm	18
70-1147-COM0051Ti. Esthetic Abut., Posterior Mini	27	(Dentsply Implants Ankylos® C/X)		
70-1147-COM0050Ti. Esthetic Abut., Posterior Standard	27	70-1139-COM0057Guide Pin (5/pk) C/X	21
(Inclusive® Tapered Implant System)			70-1139-COM0019Titanium Screw (5/pk) C/X	21
70-1073-PRA005415° Ti. Esthetic Abut., Anterior, 3.0 mmP x 1.5 mmH	8	70-1139-COM0014Titanium Screw C/X	21
70-1073-PRA005915° Ti. Esthetic Abut., Anterior, 3.0 mmP x 2.3 mmH	8	(DENTSPLY Implants ASTRA TECH Implant System®)		
70-1073-PRA000915° Ti. Esthetic Abut., Anterior, 3.5 mmP	8	70-1048-COM0110Guide Pin (5/pk) 3.0	24
70-1073-PRA003115° Ti. Esthetic Abut., Anterior, 3.5 mmP x 1.5 mmH	8	70-1048-COM0112Guide Pin (5/pk) 3.5/4.0	24
70-1073-PRA001015° Ti. Esthetic Abut., Anterior, 4.5 mmP	8	70-1048-COM0114Guide Pin (5/pk) 4.5/5.0	24
70-1073-PRA006215° Ti. Esthetic Abut., Anterior, 4.5 mmP x 1.5 mmH	8	70-1048-COM0031Titanium Screw (5/pk) 3.0	24
70-1073-PRA001315° Ti. Esthetic Abut., Posterior, 4.5 mmP	8	70-1048-COM0033Titanium Screw (5/pk) 3.5/4.0	24
70-1073-PRA0055Ti. Esthetic Abut., Anterior 3.0 mmP x 1.5 mmH	8	70-1048-COM0036Titanium Screw (5/pk) 4.5/5.0	24
70-1073-PRA0060Ti. Esthetic Abut., Anterior 3.0 mmP x 2.3 mmH	8	70-1048-COM0121Titanium Screw 3.0	24
70-1073-PRA0011Ti. Esthetic Abut., Anterior 3.5 mmP	8	70-1048-COM0122Titanium Screw 3.5/4.0	24
70-1073-PRA0032Ti. Esthetic Abut., Anterior 3.5 mmP x 1.5 mmH	8	70-1048-COM0123Titanium Screw 4.5/5.0	24
70-1073-PRA0012Ti. Esthetic Abut., Anterior 4.5 mmP	8	(Hiossen® HG System)		
70-1073-PRA0063Ti. Esthetic Abut., Anterior 4.5 mmP x 1.5 mmH	8	70-1147-COM0084Guide Pin (5/pk) Mini	27
70-1073-PRA0014Ti. Esthetic Abut., Posterior 4.5 mmP	8	70-1147-COM0083Guide Pin (5/pk) Standard	27
70-1073-PRA0015Ti. Esthetic Abut., Posterior, Wide 4.5 mmP	8	70-1147-COM0014Titanium Screw (5/pk) Mini	27
(MegaGen AnyRidge® Implant System)			70-1147-COM0015Titanium Screw (5/pk) Standard	27
70-1173-COM001915° Ti. Esthetic Abut., Anterior	30	70-1147-COM0010Titanium Screw Mini	27
70-1173-COM002115° Ti. Esthetic Abut., Posterior	30	70-1147-COM0011Titanium Screw Standard	27
70-1173-COM0020Ti. Esthetic Abut., Anterior	30	(Inclusive® Tapered Implant System)		
70-1173-COM0022Ti. Esthetic Abut., Posterior	30	70-1072-PRC0005Closed-Tray Transfer Screw	9
(NobelActive®)			70-1072-PRC0056Guide Pin 3.0 mmP (5/pk)	9
70-1050-COM009115° Ti. Esthetic Abut., Anterior NP	36	70-1072-PRC0002Guide Pin 3.5/4.5 mmP (5/pk)	9
70-1050-COM009215° Ti. Esthetic Abut., Anterior RP	36	70-1072-PRC0004Open-Tray Transfer Screw	9
70-1050-COM009315° Ti. Esthetic Abut., Posterior RP	36	70-1072-PRC0001Titanium Screw	9
70-1050-COM0094Ti. Esthetic Abut., Anterior NP	36	70-1072-PRC0058Titanium Screw 3.0 mmP	9
70-1050-COM0095Ti. Esthetic Abut., Anterior RP	36	70-1072-PRC0057Titanium Screw 3.0 mmP (5/pk)	9
70-1050-COM0096Ti. Esthetic Abut., Posterior RP	36	70-1072-PRC0003Titanium Screw 3.5/4.5 mmP (5/pk)	9
(NobelReplace®)			(MegaGen AnyRidge® Implant System)		
70-1051-COM019015° Ti. Esthetic Abut., Anterior NP	40	70-1173-COM0018Guide Pin (5/pk)	31
70-1051-COM019115° Ti. Esthetic Abut., Anterior RP	40	70-1173-COM0004Titanium Screw	31
70-1051-COM019215° Ti. Esthetic Abut., Anterior WP	40			

Parts Index

CODE	DESCRIPTION	PAGE	CODE	DESCRIPTION	PAGE
70-1173-COM0001	Titanium Screw (5/pk)	31			
(Nobel Biocare Brånemark System®)			(Hiossen® HG System)		
70-1049-COM0011	Titanium Screw (5/pk) RP	34	70-1147-COM0059	UCLA Plastic Abutment Mini	27
70-1049-COM0040	Titanium Screw RP	34	70-1147-COM0058	UCLA Plastic Abutment Standard	27
(NobelActive®)			70-1147-COM0057	UCLA Plastic Abutment, Non-Engag, Mini	27
70-1050-COM0060	Guide Pin Implant Level 20 mm (5/pk) NP	36	70-1147-COM0056	UCLA Plastic Abutment, Non-Engag, Standard	27
70-1050-COM0061	Guide Pin Implant Level 20 mm (5/pk) RP	36	(Inclusive® Tapered Implant System)		
70-1050-COM0010	Titanium Screw (5/pk) NP	36	70-1073-PRA0056	UCLA Gold Abutment 3.0 mmP	9
70-1050-COM0011	Titanium Screw (5/pk) RP	36	70-1073-PRA0027	UCLA Gold Abutment 3.5 mmP	9
70-1050-COM0064	Titanium Screw NP	36	70-1073-PRA0029	UCLA Gold Abutment 4.5 mmP	9
70-1050-COM0065	Titanium Screw RP	36	70-1073-PRA0058	UCLA Plastic Abutment 3.0 mmP	9
(NobelReplace®)			70-1073-PRA0018	UCLA Plastic Abutment 3.5 mmP	9
70-1051-COM0142	Guide Pin Implant Level 20 mm (5/pk) NP	41	70-1073-PRA0020	UCLA Plastic Abutment 4.5 mmP	9
70-1051-COM0144	Guide Pin Implant Level 20 mm (5/pk) RP/WP/6.0	41	70-1073-PRA0057	UCLA Plastic Abutment, Non-Engag, 3.0 mmP	9
70-1051-COM0019	Titanium Screw (5/pk) NP	41	70-1073-PRA0019	UCLA Plastic Abutment, Non-Engag, 3.5 mmP	9
70-1051-COM0020	Titanium Screw (5/pk) RP/WP/6.0	41	70-1073-PRA0021	UCLA Plastic Abutment, Non-Engag, 4.5 mmP	9
70-1051-COM0153	Titanium Screw NP	41	(MegaGen AnyRidge® Implant System)		
70-1051-COM0154	Titanium Screw RP/WP/6.0	41	70-1173-COM0017	UCLA Plastic Abutment	31
(Straumann® Bone Level)			70-1173-COM0016	UCLA Plastic Abutment, Non-Engag	31
70-1052-COM0059	Guide Pin (5/pk) NC	45	(Nobel Biocare Brånemark System®)		
70-1052-COM0061	Guide Pin (5/pk) RC	45	70-1049-COM0063	UCLA Plastic Abutment RP	34
70-1052-COM0020	Titanium Screw (5/pk) NC	44	70-1049-COM0064	UCLA Plastic Abutment, Non-Engag, RP	34
70-1052-COM0021	Titanium Screw (5/pk) RC	44	(NobelActive®)		
70-1052-COM0064	Titanium Screw NC	44	70-1050-COM0097	UCLA Plastic Abutment NP	36
70-1052-COM0065	Titanium Screw RC	44	70-1050-COM0098	UCLA Plastic Abutment RP	36
(Straumann® Tissue Level)			70-1050-COM0099	UCLA Plastic Abutment, Non-Engag, NP	36
70-1053-COM0072	Guide Pin (5/pk) RN/WN synOcta®	47	70-1050-COM0100	UCLA Plastic Abutment, Non-Engag, RP	36
70-1053-COM0009	Titanium Basal Screw (5/pk) RN/WN synOcta	47	(NobelReplace®)		
70-1053-COM0034	Titanium Basal Screw RN/WN synOcta	47	70-1051-COM0214	UCLA Gold Abutment 6.0	41
70-1053-COM0036	Titanium Occlusal Screw (5/pk) NN	47	70-1051-COM0211	UCLA Gold Abutment NP	41
70-1053-COM0035	Titanium Occlusal Screw NN	47	70-1051-COM0212	UCLA Gold Abutment RP	41
(Zimmer Dental Screw-Vent®)			70-1051-COM0213	UCLA Gold Abutment WP	41
70-1054-COM0084	Guide Pin (5/pk) 3.5/4.5/5.7 mm	49	70-1051-COM0204	UCLA Plastic Abutment 6.0	41
70-1054-COM0022	Titanium Screw (5/pk) 3.5/4.5/5.7 mm	49	70-1051-COM0201	UCLA Plastic Abutment NP	41
70-1054-COM0048	Titanium Screw 3.5/4.5/5.7 mm	49	70-1051-COM0202	UCLA Plastic Abutment RP	41
UCLA ABUTMENTS			70-1051-COM0203	UCLA Plastic Abutment WP	41
(BIOMET 3i™ Certain®)			70-1051-COM0208	UCLA Plastic Abutment, Non-Engag, 6.0	41
70-1047-COM0165	UCLA Plastic Abutment 3.4 mm	14	70-1051-COM0205	UCLA Plastic Abutment, Non-Engag, NP	41
70-1047-COM0166	UCLA Plastic Abutment 4.1 mm	14	70-1051-COM0206	UCLA Plastic Abutment, Non-Engag, RP	41
70-1047-COM0167	UCLA Plastic Abutment 5.0 mm	14	70-1051-COM0207	UCLA Plastic Abutment, Non-Engag, WP	41
70-1047-COM0168	UCLA Plastic Abutment 6.0 mm	14	(Straumann® Bone Level)		
70-1047-COM0169	UCLA Plastic Abutment, Non-Engag, 3.4 mm	14	70-1052-COM0095	UCLA Plastic Abutment NC	44
70-1047-COM0170	UCLA Plastic Abutment, Non-Engag, 4.1 mm	14	70-1052-COM0096	UCLA Plastic Abutment RC	44
70-1047-COM0171	UCLA Plastic Abutment, Non-Engag, 5.0 mm	14	70-1052-COM0097	UCLA Plastic Abutment, Non-Engag, NC	44
70-1047-COM0172	UCLA Plastic Abutment, Non-Engag, 6.0 mm	14	70-1052-COM0098	UCLA Plastic Abutment, Non-Engag, RC	44
(CAMLOG® SCREW-LINE)			(Straumann® Tissue Level)		
70-1135-CAM0163	UCLA Plastic Abutment, Non-Engag, 3.3 mm	18	70-1053-COM0037	UCLA Gold Abutment RN synOcta®	47
70-1135-CAM0164	UCLA Plastic Abutment, Non-Engag, 3.8 mm	18	70-1053-COM0038	UCLA Gold Abutment WN synOcta®	47
70-1135-CAM0165	UCLA Plastic Abutment, Non-Engag, 4.3 mm	18	70-1053-COM0039	UCLA Gold Abutment, Non-Engag, RN synOcta®	47
70-1135-CAM0166	UCLA Plastic Abutment, Non-Engag, 5.0 mm	18	70-1053-COM0040	UCLA Gold Abutment, Non-Engag, WN synOcta®	47
70-1135-CAM0167	UCLA Plastic Abutment, Non-Engag, 6.0 mm	18	70-1053-COM0055	UCLA Plastic Abutment RN synOcta®	47
(Dentsply Implants Ankylos® C/X)			70-1053-COM0056	UCLA Plastic Abutment WN synOcta®	47
70-1139-COM0047	UCLA Plastic Abutment, Non-Engag, C/	21	70-1053-COM0053	UCLA Plastic Abutment, Non-Engag, RN synOcta®	47
(DENTSPLY Implants ASTRA TECH Implant System®)			70-1053-COM0054	UCLA Plastic Abutment, Non-Engag, WN synOcta®	47
70-1048-COM0163	UCLA Plastic Abutment 3.0	24	(Zimmer Dental Screw-Vent®)		
70-1048-COM0164	UCLA Plastic Abutment 3.5/4.0	24	70-1054-COM0100	UCLA Plastic Abutment 3.5 mm	49
70-1048-COM0165	UCLA Plastic Abutment 4.5/5.0	24	70-1054-COM0101	UCLA Plastic Abutment 4.5 mm	49
70-1048-COM0166	UCLA Plastic Abutment, Non-Engag, 3.0	24	70-1054-COM0102	UCLA Plastic Abutment 5.7 mm	49
70-1048-COM0167	UCLA Plastic Abutment, Non-Engag, 3.5/4.0	24	70-1054-COM0103	UCLA Plastic Abutment, Non-Engag, 3.5 mm	49
70-1048-COM0168	UCLA Plastic Abutment, Non-Engag, 4.5/5.0	24	70-1054-COM0104	UCLA Plastic Abutment, Non-Engag, 4.5 mm	49
			70-1054-COM0105	UCLA Plastic Abutment, Non-Engag, 5.7 mm	49

Product Packaging

Inclusive Prosthetic Components are delivered in boxed blister trays or heat-sealed plastic pouches. They may be stored in a dry location at room temperature in this original packaging. Please refer to the individual product label for all relevant product information and cautions. Products labeled **STERILE** are intended for single-use only, prior to the expiration date. Do not use sterile products if the packaging has been compromised or previously opened. Do not re-sterilize. Products labeled **NON-STERILE** should be cleaned, disinfected, and sterilized according to a validated method prior to use in the oral environment.

Explanation of Label Codes:

1. Official product description
2. Quantity
3. Reference number (product code)
4. Lot number
5. By prescription only
6. Do not use if tampered with
7. Gamma sterilization symbol
8. Expiration date
9. Consult Instructions for Use (IFU)
10. Do not re-sterilize
11. For single-use only
12. Manufacturer
13. Country of origin
14. FDA Unique Device Identification (UDI)
15. Non-sterile
16. Notified body number
17. European Authorized Representative
18. Date of manufacture
19. Store at room temperature
20. Store at 30% to 85% relative humidity
21. Product image

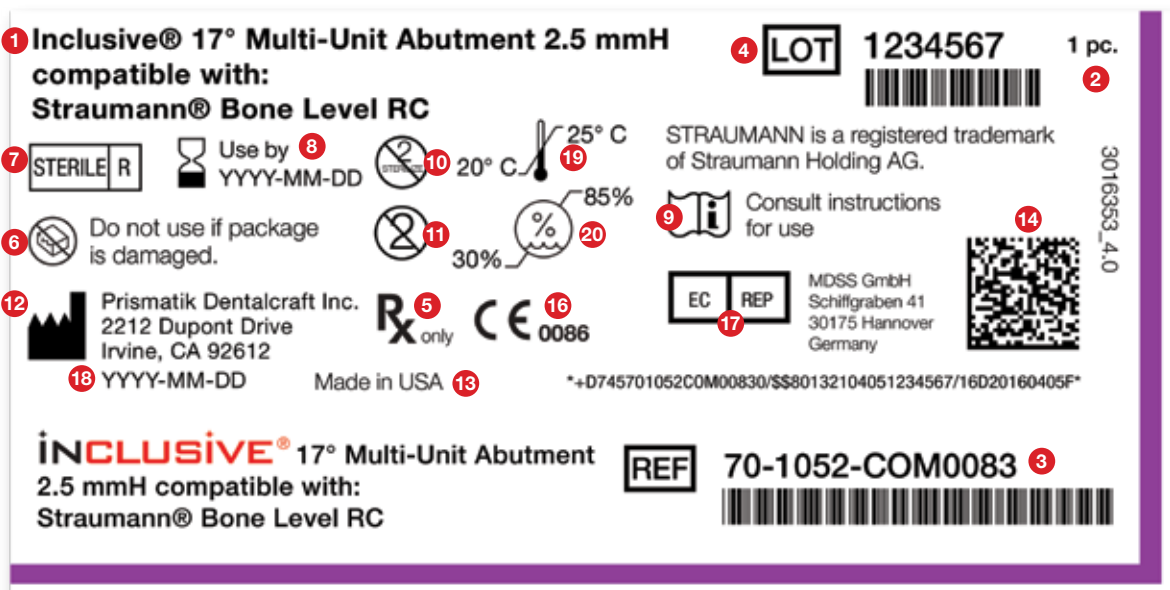
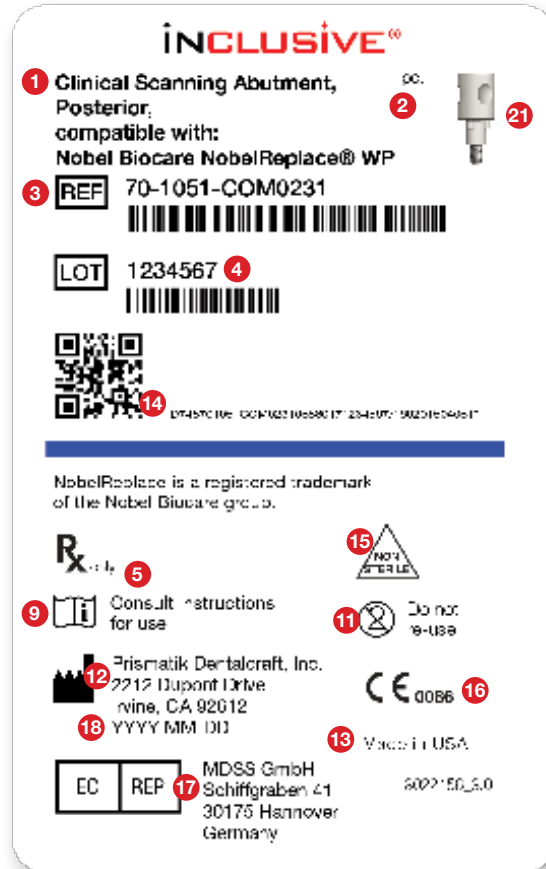

Policies and Warranty

Ordering Information

Order at glidewelldirect.com or call Glidewell Direct at 888-303-3975. Our product specialists are committed to answering questions in a timely fashion to ensure your ordering is easy and efficient. We are available Monday - Friday from 6 a.m. - 5 p.m. (PST).

Shipping Policy

- Orders placed after 3 p.m. (PST) will be processed on the following business day. Business days do not include Saturdays, Sundays, or U.S. holidays.
- Online shopping cart available to U.S. customers only.

Terms

All accounts are payable within 30 days of invoice date. Accounts not paid within the stated terms will be subject to COD status and a late charge of 2 percent of the unpaid balance. We accept American Express, Visa, MasterCard, and Discover. All prices are subject to change without notice.

Product Return Policy

Products may be returned at the customer's expense for credit within 30 days of invoice date. All returned products must meet the following conditions:

- A copy of the original invoice must accompany the products.
- Products must be packaged to arrive at the seller's facility undamaged.
- Discontinued, obsolete, expired, damaged, or opened items will not be accepted for return.
- Amount credited will be based on invoice price, less 15 percent for restocking fee.
- Shipping charges are the responsibility of the customer and will not be credited.

Product & Pricing Changes

Because products and equipment are continually undergoing refinement in design and manufacturing methods, we reserve the right to improve, modify, or discontinue products and equipment or change pricing at any time without incurring any obligation and without prior notice.

Warranty

Limited Warranty—Prismatik Dentalcraft, Inc.

Prismatik Dentalcraft, Inc. ("Prismatik"), is the manufacturer of dental products (the "product"), including Inclusive® Dental Implants ("implants"). Prismatik and Glidewell Direct hereinafter are referred to collectively as Glidewell. For a period from the original purchase date of seven (7) years for implants and six (6) months for ceramic blanks and any other product ("the warranty period"), Glidewell will at its option replace or refund the purchase price of any product, to the original purchaser ("user"), that is returned due to defects in material and manufacture.

NO GUARANTEE OR WARRANTY IS IMPLIED OTHER THAN EXPRESSLY STATED, INCLUDING ANY IMPLIED WARRANTY OF MERCHANTABILITY OR FITNESS FOR A PARTICULAR PURPOSE.

Glidewell shall not be liable for any incidental or consequential damages, whether foreseeable or not, caused by defects in the product or dental devices produced using said product. User is responsible for determining the suitability of the product for user's application. If this product is defective within the warranty period, user's exclusive remedy and Glidewell's sole obligation shall be replacement or refund of the purchase price of the product. For replacement or refund under this warranty, the original purchaser shall send the product at its own expense, postage prepaid, to Glidewell Direct, 18651 Von Karman Ave, Irvine, CA 92612.



INCLUSIVE[®]
PROSTHETIC COMPONENTS



Designed & Manufactured in the U.S.A.
by



(A wholly owned subsidiary of Glidewell Laboratories)
2212 Dupont Dr. • Irvine, CA 92612

Distributed by



CLINICAL AND LABORATORY PRODUCTS
18651 Von Karman Ave. • Irvine, CA 92612

To Order Call:

888-303-3975

Online:

glidewelldirect.com

CE 0086

EC REP

MDSS GmbH
Schiffgraben 41
30175 Hannover, Germany

MKT 3641_9.0 (3008614)

GD-436-081518