

**INCLUSIVE**<sup>®</sup>  
PROSTHETIC COMPONENTS



**bsi.**

# Certificate of Registration



By Royal Charter

QUALITY MANAGEMENT SYSTEM - ISO 13485:2003

This is to certify that:

Prismatik Dentalcraft, Inc.  
a wholly owned subsidiary of  
Glidewell Laboratories  
2212 Dupont Drive  
Irvine  
California  
92612  
USA

Holds Certificate No:

**FM 573328**

and operates a Quality Management System which complies with the requirements of ISO 13485:2003 for the following scope:

Design and manufacturing of dental restorative products.

The above scope of registration includes activities at:  
2181 Dupont Drive, Irvine CA  
18651 Von Karman, Irvine CA

For and on behalf of BSI:

VP Regulatory Affairs, BSI Group America Inc.

Originally registered: 09/02/2011

Effective Date: 08/25/2014

Expiry Date: 08/24/2017



CMDCAS  
Recognized  
Registrar



...making excellence a habit.™

---

## Introducing Inclusive® Prosthetic Components

---

Founded in 2006 with the goal of expanding the availability of comprehensive dental implant therapy to patients across the economic spectrum, Prismatik Dentalcraft reduces the component and restorative cost of treatment while maintaining the highest standard of quality. Having assembled a diverse team of experts with decades of combined experience in the design, engineering, and manufacture of dental implants, along with a staff of highly respected researchers, material scientists, clinical specialists, restorative doctors, and dental technicians, we at Prismatik are dedicated to advancing implant dentistry by combining proven treatment protocols with cutting-edge materials, technologies, and techniques.

Prosthetic components for the Inclusive® Tapered Implant System include a wide array of esthetic and multi-unit titanium abutments, along with analogs, screws, temporary and UCLA abutments, digital and conventional transfer copings, and more. Prismatik Dentalcraft also has FDA 510(k) clearance for prosthetic connections that are compatible with several of the industry's other leading implant manufacturers. Prosthetic components manufactured by Prismatik Dentalcraft are produced in an ISO 13485 certified environment in Irvine, California, operating under U.S. Food and Drug Administration Current Good Manufacturing Practices (CGMPs). This ensures tight tolerances, precision machining, state-of-the-art processing and cleaning, and extensive validation testing — from fatigue strength assessment to packaging integrity analysis. Uniform component costs across systems allow for predictable pricing. The result is a product that offers immediate value and lasting quality.

From its beginnings until today, Prismatik Dentalcraft has experienced an ever-growing demand in support of its vision to make dental implant therapy more accessible to patients around the globe. This growth has enabled the company to consistently expand and improve its offerings even in a time of widespread economic challenge. The Inclusive brand has quickly established itself as a trusted name within the industry, and Prismatik Dentalcraft as a manufacturer at the forefront of dental technology.

Thank you for choosing Prismatik. You can place your trust in us.



Copyright © 2016, Prismatik Dentalcraft, Inc. Prismatik Dentalcraft, Inc. is not responsible for any damages or other liabilities (including attorney fees) resulting, or claimed to result in whole or in part, from actual or alleged problems arising out of the use of this information. The techniques, procedures and theories presented herein are provided in good faith and believed to be correct as of the date hereof. Any dental professional viewing this presentation must make his or her own decisions about the use of the materials and techniques for specific situations.

*No representations as to the completeness or accuracy of this information is given, and no representations or warranties, either expressed or implied, of merchantability, fitness for a particular purpose or of any other nature are made here under with respect to the information or the product to which information refers.*

---

# Contents

---

**6 Inclusive® Tapered Implant System**

*Implant components compatible with the following third-party implant systems:*

12 BIOMET 3i™ Certain®

16 CAMLOG® SCREW-LINE

20 DENTSPLY Implants ASTRA TECH Implant System®

24 Keystone Dental PrimaConnex®

24 Neoss®

25 Nobel Biocare Brånemark System®

27 Nobel Biocare NobelActive®

30 Nobel Biocare NobelReplace®

35 Straumann® Bone Level

38 Straumann® Tissue Level

39 Zimmer Dental Screw-Vent®

41 Inclusive Prosthetic Kit

42 Laboratory Scanning Abutment Kit

**43 Parts Index**

**50 Product Packaging**

**51 Policies & Warranty**



*Inclusive is a registered trademark of Prismatic Dentalcraft, Inc.*

*BIOMET 3i is a trademark and CERTAIN a registered trademark of BIOMET 3i, LLC.*

*CAMLOG is a registered trademark of Camlog Biotechnologies AG.*

*ASTRA TECH IMPLANT SYSTEM is a registered trademark of Dentsply IH AB LLC.*

*PRIMACONNEX is a registered trademark of Keystone Dental, Inc.*

*NEOSS is a registered trademark of Neoss Limited.*

*Brånemark System, NobelActive, and NobelReplace are registered trademarks of the Nobel Biocare group.*

*STRAUMANN is a registered trademark of Straumann Holding AG.*

*SCREW-VENT is a registered trademark of Zimmer Dental Inc.*

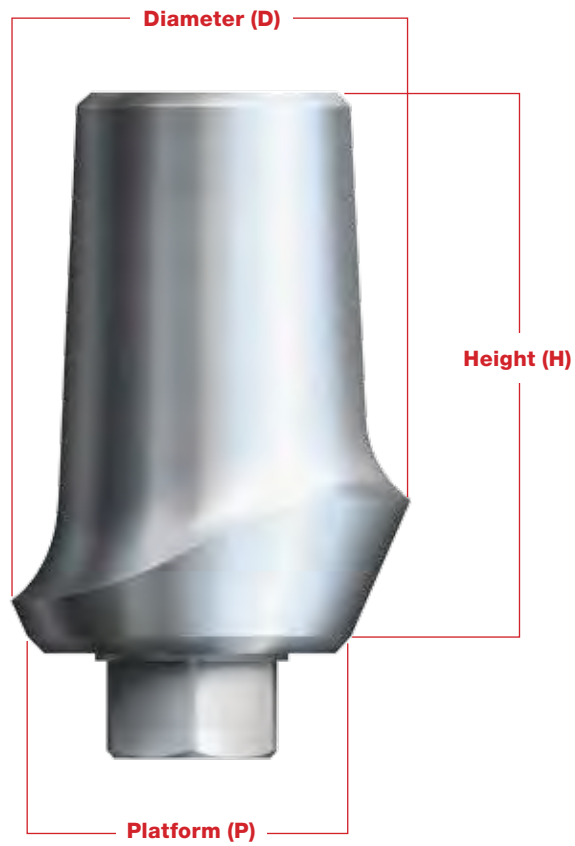
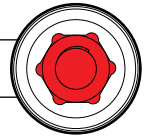

**Ø3.2 mm**

**Ø3.7 mm**

**Ø4.2 mm**

**Ø4.7 mm**

**Ø5.2 mm**



Ø3.0 mm platform  
– conical connection –



Ø3.5 mm platform



Ø3.5 mm platform





Ø4.5 mm platform

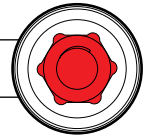

Ø4.5 mm platform



## IMPLANT ANALOGS

	Description	Code
 70-1072-PRC0055	Inclusive® Tapered Implant Analog 3.0 mmP	70-1072-PRC0055
 70-1072-PRC0015	Inclusive® Tapered Implant Analog 3.5 mmP	70-1072-PRC0015
 70-1072-PRC0017	Inclusive® Tapered Implant Analog 4.5 mmP	70-1072-PRC0017

## IMPRESSION TRANSFERS

 70-1072-PRC0051	 70-1072-PRC0053	Inclusive® Tapered Implant Transfer Coping, Closed-Tray, 3.0 mmP x 3.2 mmD Inclusive® Tapered Implant Transfer Coping, Closed-Tray, 3.0 mmP x 3.7 mmD	70-1072-PRC0051 70-1072-PRC0053
 70-1072-PRC0007	 70-1072-PRC0009	Inclusive® Tapered Implant Transfer Coping, Closed-Tray, 3.5 mmP x 3.5 mmD Inclusive® Tapered Implant Transfer Coping, Closed-Tray, 3.5 mmP x 4.7 mmD	70-1072-PRC0007 70-1072-PRC0009
 70-1072-PRC0011	 70-1072-PRC0013	Inclusive® Tapered Implant Transfer Coping, Closed-Tray, 4.5 mmP x 4.5 mmD Inclusive® Tapered Implant Transfer Coping, Closed-Tray, 4.5 mmP x 5.7 mmD <i>(Closed-Tray Transfer Copings include Closed-Tray Screw.)</i>	70-1072-PRC0011 70-1072-PRC0013
 70-1072-PRC0052	 70-1072-PRC0054	Inclusive® Tapered Implant Transfer Coping, Open-Tray, 3.0 mmP x 3.2 mmD Inclusive® Tapered Implant Transfer Coping, Open-Tray, 3.0 mmP x 3.7 mmD	70-1072-PRC0052 70-1072-PRC0054
 70-1072-PRC0006	 70-1072-PRC0008	Inclusive® Tapered Implant Transfer Coping, Open-Tray, 3.5 mmP x 3.5 mmD Inclusive® Tapered Implant Transfer Coping, Open-Tray, 3.5 mmP x 4.7 mmD	70-1072-PRC0006 70-1072-PRC0008
 70-1072-PRC0010	 70-1072-PRC0012	Inclusive® Tapered Implant Transfer Coping, Open-Tray, 4.5 mmP x 4.5 mmD Inclusive® Tapered Implant Transfer Coping, Open-Tray, 4.5 mmP x 5.7 mmD <i>(Open-Tray Transfer Copings include Open-Tray Screw and Guide Pin.)</i>	70-1072-PRC0010 70-1072-PRC0012

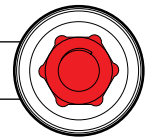

## SCANNING ABUTMENTS

Description

Code



**Clinical Use (radiopaque)**

Inclusive® Tapered Implant Clinical Scanning Abutment, Anterior, 3.0 mmP

70-1073-PRA0051

Inclusive® Tapered Implant Clinical Scanning Abutment, Anterior, 3.5 mmP

70-1073-PRA0042

Inclusive® Tapered Implant Clinical Scanning Abutment, Anterior, 4.5 mmP

70-1073-PRA0043



**Clinical Use (radiopaque)**

Inclusive® Tapered Implant Clinical Scanning Abutment, Posterior, 3.0 mmP

70-1073-PRA0050

Inclusive® Tapered Implant Clinical Scanning Abutment, Posterior, 3.5 mmP

70-1073-PRA0040

Inclusive® Tapered Implant Clinical Scanning Abutment, Posterior, 4.5 mmP

70-1073-PRA0041



**Laboratory Packs (radiolucent)**

Inclusive® Tapered Implant Laboratory Scanning Abutment 3.0 mmP (3-pack)

70-1073-PRA0049

Inclusive® Tapered Implant Laboratory Scanning Abutment 3.5 mmP (3-pack)

70-1073-PRA0033

Inclusive® Tapered Implant Laboratory Scanning Abutment 4.5 mmP (3-pack)

70-1073-PRA0034

*(Scanning Abutments include Captured Screw.)*



## TEMPORARY ABUTMENTS

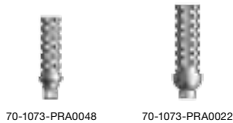

Inclusive® Tapered Implant Temporary Abutment 3.0 mmP

70-1073-PRA0048

Inclusive® Tapered Implant Temporary Abutment 3.5 mmP

70-1073-PRA0022

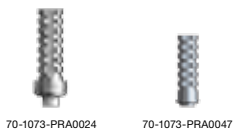

Inclusive® Tapered Implant Temporary Abutment 4.5 mmP

70-1073-PRA0024

Inclusive® Tapered Implant Temporary Abutment, Non-Engaging, 3.0 mmP

70-1073-PRA0047

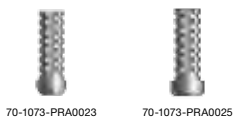

Inclusive® Tapered Implant Temporary Abutment, Non-Engaging, 3.5 mmP

70-1073-PRA0023

Inclusive® Tapered Implant Temporary Abutment, Non-Engaging, 4.5 mmP



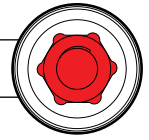

70-1073-PRA0025

*(Temporary Abutments include Titanium Screw and Guide Pin.)*













## TITANIUM ABUTMENTS

Description		Code
	Inclusive® Tapered Implant Titanium Abutment 3.0 mmP x 4.5 mmH	70-1073-PRA0052
	Inclusive® Tapered Implant Titanium Abutment 3.0 mmP x 6 mmH	70-1073-PRA0053
	Inclusive® Tapered Implant Titanium Abutment 3.5 mmP x 6 mmH	70-1073-PRA0006
	Inclusive® Tapered Implant Titanium Abutment 4.5 mmP x 6 mmH	70-1073-PRA0008

*(Titanium Screw sold separately; please see page 9.)*

## TITANIUM ESTHETIC ABUTMENTS







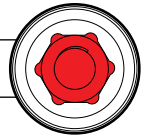



















	Inclusive® Tapered Implant 15° Titanium Esthetic Abutment, Anterior, 3.0 mmP x 1.5 mmH	70-1073-PRA0054
	Inclusive® Tapered Implant 15° Titanium Esthetic Abutment, Anterior, 3.0 mmP x 2.3 mmH	70-1073-PRA0059
	Inclusive® Tapered Implant 15° Titanium Esthetic Abutment, Anterior, 3.5 mmP	70-1073-PRA0009
	Inclusive® Tapered Implant 15° Titanium Esthetic Abutment, Anterior, 4.5 mmP	70-1073-PRA0010
	Inclusive® Tapered Implant 15° Titanium Esthetic Abutment, Posterior, 4.5 mmP	70-1073-PRA0013
	Inclusive® Tapered Implant Titanium Esthetic Abutment, Anterior, 3.0 mmP x 1.5 mmH	70-1073-PRA0055
	Inclusive® Tapered Implant Titanium Esthetic Abutment, Anterior, 3.0 mmP x 2.3 mmH	70-1073-PRA0060
	Inclusive® Tapered Implant Titanium Esthetic Abutment, Anterior, 3.5 mmP	70-1073-PRA0011
	Inclusive® Tapered Implant Titanium Esthetic Abutment, Anterior, 4.5 mmP	70-1073-PRA0012
	Inclusive® Tapered Implant Titanium Esthetic Abutment, Posterior, 4.5 mmP	70-1073-PRA0014
	Inclusive® Tapered Implant Titanium Esthetic Abutment, Posterior, Wide, 4.5 mmP	70-1073-PRA0015

*(Esthetic Abutments include Titanium Screw.)*





















## UCLA ABUTMENTS

Description			Code
			70-1073-PRA0056
			70-1073-PRA0027
			70-1073-PRA0029
			70-1073-PRA0058
			70-1073-PRA0018
			70-1073-PRA0020
			70-1073-PRA0057
			70-1073-PRA0019
			70-1073-PRA0021







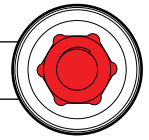









*(UCLA Abutments include Titanium Screw and Guide Pin.)*

## TITANIUM SCREWS AND GUIDE PINS

		Inclusive® Tapered Implant Titanium Screw 3.0 mmP	70-1072-PRC0058
		Inclusive® Tapered Implant Titanium Screw 3.0 mmP (5-pack)	70-1072-PRC0057
		Inclusive® Tapered Implant Titanium Screw	70-1072-PRC0001
		Inclusive® Tapered Implant Titanium Screw (5-pack)	70-1072-PRC0003
		Inclusive® Tapered Implant Guide Pin 3.0 mmP (5-pack)	70-1072-PRC0056
		Inclusive® Tapered Implant Guide Pin (5-pack)	70-1072-PRC0002
		Inclusive® Tapered Implant Closed-Tray Transfer Screw	70-1072-PRC0005
		Inclusive® Tapered Implant Open-Tray Transfer Screw	70-1072-PRC0004



## MULTI-UNIT ABUTMENTS

Description		Code
	Inclusive® Tapered Implant Multi-Unit Abutment 3.0 mmP x 1.5 mmH	70-1074-PRS0040
	Inclusive® Tapered Implant Multi-Unit Abutment 3.0 mmP x 2.5 mmH	70-1074-PRS0041
	Inclusive® Tapered Implant Multi-Unit Abutment 3.0 mmP x 3.5 mmH	70-1074-PRS0042
	Inclusive® Tapered Implant Multi-Unit Abutment 3.5 mmP x 1 mmH	70-1074-PRS0009
	Inclusive® Tapered Implant Multi-Unit Abutment 3.5 mmP x 2 mmH	70-1074-PRS0010
	Inclusive® Tapered Implant Multi-Unit Abutment 4.5 mmP x 1 mmH	70-1074-PRS0011
	Inclusive® Tapered Implant Multi-Unit Abutment 4.5 mmP x 2 mmH	70-1074-PRS0012
	Inclusive® Tapered Implant Multi-Unit Abutment 4.5 mmP x 3 mmH	70-1074-PRS0013
	Inclusive® Tapered Implant Multi-Unit Abutment 4.5 mmP x 5 mmH <i>(Prosthetic Screw sold separately; please see page 11.)</i>	70-1074-PRS0014
	Inclusive® Tapered Implant 17° Multi-Unit Abutment 3.5 mmP x 2 mmH	70-1074-PRS0001
	Inclusive® Tapered Implant 17° Multi-Unit Abutment 3.5 mmP x 3 mmH	70-1074-PRS0002
	Inclusive® Tapered Implant 17° Multi-Unit Abutment 4.5 mmP x 2 mmH	70-1074-PRS0003
	Inclusive® Tapered Implant 17° Multi-Unit Abutment 4.5 mmP x 3 mmH	70-1074-PRS0004
	Inclusive® Tapered Implant 17° Multi-Unit Abutment 4.5 mmP x 5 mmH	70-1074-PRS0005
	Inclusive® Tapered Implant 30° Multi-Unit Abutment 3.5 mmP x 3 mmH	70-1074-PRS0006
	Inclusive® Tapered Implant 30° Multi-Unit Abutment 4.5 mmP x 3 mmH	70-1074-PRS0007
	Inclusive® Tapered Implant 30° Multi-Unit Abutment 4.5 mmP x 5 mmH <i>(Angled Multi-Unit Abutments include Angled Abutment Screw. Prosthetic Screw sold separately; please see page 11.)</i>	70-1074-PRS0008

## MULTI-UNIT TITANIUM SCREWS



Inclusive® Angled Multi-Unit Abutment Screw







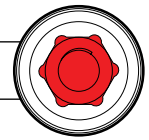





70-1074-PRS0031

# INCLUSIVE® Tapered Implant System

Unigrip is a trademark of the Nobel Biocare group.



## MULTI-UNIT ABUTMENT ACCESSORIES



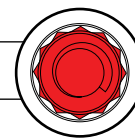

	Description	Code
 	Inclusive® Multi-Unit Abutment Analog	70-1074-PRS0016
	Inclusive® Multi-Unit Driver	70-1074-PRS0028
	Inclusive® Multi-Unit Gold/Plastic Coping	70-1074-PRS0030
	Inclusive® Multi-Unit Gold Bar Coping	70-1074-PRS0018
 	Inclusive® Multi-Unit Impression Coping, Closed-Tray	70-1074-PRS0021
	Inclusive® Multi-Unit Plastic Coping with Prosthetic Screw .048" Hex with Prosthetic Screw .050" Hex with Prosthetic Screw 1.0 mm Hex with Prosthetic Screw SCS with Prosthetic Screw - Unigrip™ Driver	70-1074-PRS0068 70-1074-PRS0067 70-1074-PRS0071 70-1074-PRS0070 70-1074-PRS0069
	Inclusive® Multi-Unit Impression Coping, Open-Tray with Guide Pin .048" Hex with Guide Pin .050" Hex with Guide Pin 1.0 mm Hex with Guide Pin SCS with Guide Pin - Unigrip™ Driver	70-1074-PRS0053 70-1074-PRS0052 70-1074-PRS0055 70-1074-PRS0054 70-1074-PRS0022
	Inclusive® Multi-Unit Temporary Healing Cap with Prosthetic Screw .048" Hex with Prosthetic Screw .050" Hex with Prosthetic Screw 1.0 mm Hex with Prosthetic Screw SCS with Prosthetic Screw - Unigrip™ Driver	70-1074-PRS0043 70-1074-PRS0015 70-1074-PRS0046 70-1074-PRS0045 70-1074-PRS0044
	Inclusive® Multi-Unit Coping 4.5 mmH, Non-Engaging with Prosthetic Screw .048" Hex with Prosthetic Screw .050" Hex with Prosthetic Screw 1.0 mm Hex with Prosthetic Screw SCS with Prosthetic Screw - Unigrip™ Driver	70-1074-PRS0047 70-1073-PRA0037 70-1074-PRS0050 70-1074-PRS0049 70-1074-PRS0048
	Inclusive® Multi-Unit Guide Pin .048" Hex .050" Hex 1.0 mm Hex SCS Unigrip™ Driver	70-1074-PRS0035 70-1074-PRS0061 70-1074-PRS0036 70-1074-PRS0037 70-1074-PRS0019
	Inclusive® Multi-Unit Titanium Temporary with Prosthetic Screw .048" Hex with Prosthetic Screw .050" Hex with Prosthetic Screw 1.0 mm Hex with Prosthetic Screw SCS with Prosthetic Screw - Unigrip™ Driver	70-1074-PRS0056 70-1074-PRS0025 70-1074-PRS0059 70-1074-PRS0058 70-1074-PRS0057
	Inclusive® Multi-Unit Prosthetic Screw .048" Hex .050" Hex 1.0 mm Hex SCS Unigrip™ Driver	70-1047-COM0153 70-1072-PRC0014 70-1074-PRS0060 70-1052-COM0088 70-1072-PRC0043

# Implant components compatible with: **BIOMET 3i™ Certain®**





BIOMET 3i and Certain are trademarks of BIOMET 3i, LLC.











## IMPLANT ANALOGS





Description (with Platform Size)		Code
	Inclusive® Implant Analog (5-pack)* 3.4 mm	70-1047-COM0013
	Inclusive® Implant Analog (5-pack)* 4.1 mm	70-1047-COM0014
	Inclusive® Implant Analog (5-pack)* 5.0 mm	70-1047-COM0015
	Inclusive® Implant Analog (5-pack)* 6.0 mm	70-1047-COM0016

## SCANNING ABUTMENTS

	<b>Clinical Use (radiopaque)</b> Inclusive® Clinical Scanning Abutment, Anterior* 3.4 mm	70-1047-COM0118
	Inclusive® Clinical Scanning Abutment, Anterior* 4.1 mm	70-1047-COM0119
	Inclusive® Clinical Scanning Abutment, Anterior* 5.0 mm	70-1047-COM0120
	Inclusive® Clinical Scanning Abutment, Anterior* 6.0 mm	70-1047-COM0121

	<b>Clinical Use (radiopaque)</b> Inclusive® Clinical Scanning Abutment, Posterior* 3.4 mm	70-1047-COM0187
	Inclusive® Clinical Scanning Abutment, Posterior* 4.1 mm	70-1047-COM0188
	Inclusive® Clinical Scanning Abutment, Posterior* 5.0 mm	70-1047-COM0189
	Inclusive® Clinical Scanning Abutment, Posterior* 6.0 mm	70-1047-COM0190

	<b>Laboratory Packs (radiolucent)</b> Inclusive® Laboratory Scanning Abutment (3-pack)* 3.4 mm	70-1047-COM0175
	Inclusive® Laboratory Scanning Abutment (3-pack)* 4.1 mm	70-1047-COM0176
	Inclusive® Laboratory Scanning Abutment (3-pack)* 5.0 mm	70-1047-COM0177
	Inclusive® Laboratory Scanning Abutment (3-pack)* 6.0 mm	70-1047-COM0178

	<b>Blue Light Scanner Laboratory Packs (radiolucent)</b> Inclusive® Laboratory Scanning Abutment† (3-pack)* 3.4 mm	70-1047-COM0200
	Inclusive® Laboratory Scanning Abutment† (3-pack)* 4.1 mm	70-1047-COM0201
	Inclusive® Laboratory Scanning Abutment† (3-pack)* 5.0 mm	70-1047-COM0202
	Inclusive® Laboratory Scanning Abutment† (3-pack)* 6.0 mm	70-1047-COM0203

†for Blue Light Scanners

(Scanning Abutments include Captured Screw.)







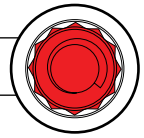

\*compatible with: Biomet 3i™ Certain®

# Implant components compatible with: **BIOMET 3i™ Certain®**

BIOMET 3i and Certain are trademarks of BIOMET 3i, LLC.



## BITE VERIFICATION CYLINDERS

Description (with Platform Size)		Code
	Inclusive® Bite Verification Cylinder* 3.4 mm	70-1047-COM0130
	Inclusive® Bite Verification Cylinder* 4.1 mm	70-1047-COM0131
	Inclusive® Bite Verification Cylinder* 5.0 mm	70-1047-COM0132
	Inclusive® Bite Verification Cylinder* 6.0 mm	70-1047-COM0133
	Inclusive® Bite Verification Cylinder, Non-Engaging* 3.4 mm	70-1047-COM0126
	Inclusive® Bite Verification Cylinder, Non-Engaging* 4.1 mm	70-1047-COM0127
	Inclusive® Bite Verification Cylinder, Non-Engaging* 5.0 mm	70-1047-COM0128
	Inclusive® Bite Verification Cylinder, Non-Engaging* 6.0 mm	70-1047-COM0129





*(Bite Verification Cylinders include Titanium Screw and Guide Pin.)*

## TITANIUM ABUTMENTS

	Inclusive® Titanium Abutment 4.5 mmH* 3.4 mm	70-1047-COM0084
	Inclusive® Titanium Abutment 4.5 mmH* 4.1 mm	70-1047-COM0086
	Inclusive® Titanium Abutment 4.5 mmH* 5.0 mm	70-1047-COM0088
	Inclusive® Titanium Abutment 4.5 mmH* 6.0 mm	70-1047-COM0090
	Inclusive® Titanium Abutment 6 mmH* 3.4 mm	70-1047-COM0005
	Inclusive® Titanium Abutment 6 mmH* 4.1 mm	70-1047-COM0006
	Inclusive® Titanium Abutment 6 mmH* 5.0 mm	70-1047-COM0007
	Inclusive® Titanium Abutment 6 mmH* 6.0 mm	70-1047-COM0008
	Inclusive® Titanium Abutment 4.5 mmH, Non-Engaging* 3.4 mm	70-1047-COM0092
	Inclusive® Titanium Abutment 4.5 mmH, Non-Engaging* 4.1 mm	70-1047-COM0094
	Inclusive® Titanium Abutment 4.5 mmH, Non-Engaging* 5.0 mm	70-1047-COM0096
	Inclusive® Titanium Abutment 4.5 mmH, Non-Engaging* 6.0 mm	70-1047-COM0098

*(Titanium Screw sold separately; please see page 14.)*

## TITANIUM ESTHETIC ABUTMENTS

	Inclusive® 15° Titanium Esthetic Abutment, Anterior* 3.4 mm	70-1047-COM0154
	Inclusive® 15° Titanium Esthetic Abutment, Anterior* 4.1 mm	70-1047-COM0155
	Inclusive® 15° Titanium Esthetic Abutment, Anterior* 5.0 mm	70-1047-COM0156
	Inclusive® 15° Titanium Esthetic Abutment, Posterior* 4.1 mm	70-1047-COM0157
	Inclusive® 15° Titanium Esthetic Abutment, Posterior* 5.0 mm	70-1047-COM0158

*(Esthetic Abutments include Titanium Screw.)*





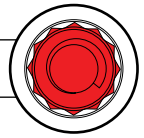

\*compatible with: Biomet 3i™ Certain®

# Implant components compatible with: **BIOMET 3i™ Certain®**

BIOMET 3i and Certain are trademarks of BIOMET 3i, LLC.





## TITANIUM ESTHETIC ABUTMENTS









Description (with Platform Size)			Code	
			Inclusive® Titanium Esthetic Abutment, Anterior* 3.4 mm 70-1047-COM0159	70-1047-COM0159
			Inclusive® Titanium Esthetic Abutment, Anterior* 4.1 mm 70-1047-COM0160	70-1047-COM0160
			Inclusive® Titanium Esthetic Abutment, Anterior* 5.0 mm 70-1047-COM0161	70-1047-COM0161
			Inclusive® Titanium Esthetic Abutment, Posterior* 4.1 mm 70-1047-COM0162	70-1047-COM0162
			Inclusive® Titanium Esthetic Abutment, Posterior* 4.1 mm 70-1047-COM0162	70-1047-COM0162
			Inclusive® Titanium Esthetic Abutment, Posterior* 5.0 mm 70-1047-COM0163	70-1047-COM0163
			Inclusive® Titanium Esthetic Abutment, Posterior* 6.0 mm 70-1047-COM0164	70-1047-COM0164

*(Esthetic Abutments include Titanium Screw.)*

## TITANIUM ABUTMENT BLANKS



		Inclusive® Titanium Abutment Blank* 3.4 mm 70-1047-COM0054	70-1047-COM0054
		Inclusive® Titanium Abutment Blank* 4.1 mm 70-1047-COM0055	70-1047-COM0055
		Inclusive® Titanium Abutment Blank* 5.0 mm 70-1047-COM0056	70-1047-COM0056
		Inclusive® Titanium Abutment Blank* 6.0 mm 70-1047-COM0057	70-1047-COM0057

## UCLA PLASTIC ABUTMENTS

		Inclusive® UCLA Plastic Abutment* 3.4 mm 70-1047-COM0165	70-1047-COM0165
		Inclusive® UCLA Plastic Abutment* 4.1 mm 70-1047-COM0166	70-1047-COM0166
		Inclusive® UCLA Plastic Abutment* 5.0 mm 70-1047-COM0167	70-1047-COM0167
		Inclusive® UCLA Plastic Abutment* 6.0 mm 70-1047-COM0168	70-1047-COM0168
		Inclusive® UCLA Plastic Abutment, Non-Engaging* 3.4 mm 70-1047-COM0169	70-1047-COM0169
		Inclusive® UCLA Plastic Abutment, Non-Engaging* 4.1 mm 70-1047-COM0170	70-1047-COM0170
		Inclusive® UCLA Plastic Abutment, Non-Engaging* 5.0 mm 70-1047-COM0171	70-1047-COM0171
		Inclusive® UCLA Plastic Abutment, Non-Engaging* 6.0 mm 70-1047-COM0172	70-1047-COM0172

*(UCLA Abutments include Titanium Screw and Guide Pin.)*

## TITANIUM SCREWS AND GUIDE PINS

		Inclusive® Titanium Screw* 3.4/4.1/5.0/6.0 mm 70-1047-COM0117	70-1047-COM0117
		Inclusive® Titanium Screw (5-pack)* 3.4/4.1/5.0/6.0 mm 70-1047-COM0029	70-1047-COM0029
		Inclusive® Guide Pin (5-pack)* 3.4/4.1/5.0/6.0 mm 70-1047-COM0112	70-1047-COM0112

\*compatible with: Biomet 3i™ Certain®

# Implant components compatible with: **BIOMET 3i™ Certain®**

BIOMET 3i and Certain are trademarks of BIOMET 3i, LLC.

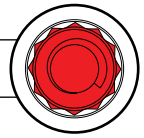

## MULTI-UNIT ABUTMENTS

Description (with Platform Size)		Code		
			Inclusive® Multi-Unit Abutment 1 mmH* 3.4 mm	70-1047-COM0134
70-1047-COM0134	70-1047-COM0135	70-1047-COM0136	Inclusive® Multi-Unit Abutment 2 mmH* 3.4 mm	70-1047-COM0135
			Inclusive® Multi-Unit Abutment 3 mmH* 3.4 mm	70-1047-COM0136
			Inclusive® Multi-Unit Abutment 1 mmH* 4.1 mm	70-1047-COM0137
70-1047-COM0137	70-1047-COM0138		Inclusive® Multi-Unit Abutment 2 mmH* 4.1 mm	70-1047-COM0138
			Inclusive® Multi-Unit Abutment 3 mmH* 4.1 mm	70-1047-COM0139
70-1047-COM0139	70-1047-COM0140		Inclusive® Multi-Unit Abutment 5 mmH* 4.1 mm	70-1047-COM0140
			Inclusive® Multi-Unit Abutment 1 mmH* 5.0 mm	70-1047-COM0141
70-1047-COM0141	70-1047-COM0142	70-1047-COM0143	Inclusive® Multi-Unit Abutment 2 mmH* 5.0 mm	70-1047-COM0142
			Inclusive® Multi-Unit Abutment 3 mmH* 5.0 mm	70-1047-COM0143
<i>(Prosthetic Screw sold separately; please see page 11.)</i>				
			Inclusive® 17° Multi-Unit Abutment 2 mmH* 3.4 mm	70-1047-COM0144
70-1047-COM0144	70-1047-COM0145		Inclusive® 17° Multi-Unit Abutment 3 mmH* 3.4 mm	70-1047-COM0145
			Inclusive® 17° Multi-Unit Abutment 2 mmH* 4.1 mm	70-1047-COM0146
70-1047-COM0146	70-1047-COM0147		Inclusive® 17° Multi-Unit Abutment 3 mmH* 4.1 mm	70-1047-COM0147
			Inclusive® 17° Multi-Unit Abutment 2 mmH* 5.0 mm	70-1047-COM0148
70-1047-COM0148	70-1047-COM0149		Inclusive® 17° Multi-Unit Abutment 3 mmH* 5.0 mm	70-1047-COM0149
			Inclusive® 30° Multi-Unit Abutment 4 mmH* 4.1 mm	70-1047-COM0150
70-1047-COM0150	70-1047-COM0151		Inclusive® 30° Multi-Unit Abutment 5 mmH* 4.1 mm	70-1047-COM0151
<i>(Angled Multi-Unit Abutments include Angled Abutment Screw. Prosthetic Screw sold separately; please see page 11.)</i>				

## MULTI-UNIT TITANIUM SCREWS



Inclusive® Angled Multi-Unit Abutment Screw\* 3.4/4.1/5.0/6.0 mm 70-1047-COM0152

## MULTI-UNIT ABUTMENT ACCESSORIES

**For a complete line of Multi-Unit Abutment Accessories, please see page 11.**

*\*compatible with: Biomet 3i™ Certain®*





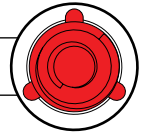

# Implant components compatible with: CAMLOG® SCREW-LINE













CAMLOG is a registered trademark of Camlog Biotechnologies AG.





## IMPLANT ANALOGS





Description (with Platform Size)		Code
	Inclusive® Implant Analog (5-pack)* 3.3 mm	70-1135-CAM0068
	Inclusive® Implant Analog (5-pack)* 3.8 mm	70-1135-CAM0070
	Inclusive® Implant Analog (5-pack)* 4.3 mm	70-1135-CAM0072
	Inclusive® Implant Analog (5-pack)* 5.0 mm	70-1135-CAM0074
	Inclusive® Implant Analog (5-pack)* 6.0 mm	70-1135-CAM0076

## SCANNING ABUTMENTS

	<b>Clinical Use (radiopaque)</b>	
	Inclusive® Clinical Scanning Abutment, Anterior* 3.3 mm	70-1135-CAM0092
	Inclusive® Clinical Scanning Abutment, Anterior* 3.8 mm	70-1135-CAM0093
	Inclusive® Clinical Scanning Abutment, Anterior* 4.3 mm	70-1135-CAM0094
	Inclusive® Clinical Scanning Abutment, Anterior* 5.0 mm	70-1135-CAM0095
	Inclusive® Clinical Scanning Abutment, Anterior* 6.0 mm	70-1135-CAM0096

	<b>Clinical Use (radiopaque)</b>	
	Inclusive® Clinical Scanning Abutment, Posterior* 3.3 mm	70-1135-CAM0182
	Inclusive® Clinical Scanning Abutment, Posterior* 3.8 mm	70-1135-CAM0183
	Inclusive® Clinical Scanning Abutment, Posterior* 4.3 mm	70-1135-CAM0184
	Inclusive® Clinical Scanning Abutment, Posterior* 5.0 mm	70-1135-CAM0185
	Inclusive® Clinical Scanning Abutment, Posterior* 6.0 mm	70-1135-CAM0186

	<b>Laboratory Packs (radiolucent)</b>	
	Inclusive® Laboratory Scanning Abutment (3-pack)* 3.3 mm	70-1135-CAM0172
	Inclusive® Laboratory Scanning Abutment (3-pack)* 3.8 mm	70-1135-CAM0173
	Inclusive® Laboratory Scanning Abutment (3-pack)* 4.3 mm	70-1135-CAM0174
	Inclusive® Laboratory Scanning Abutment (3-pack)* 5.0 mm	70-1135-CAM0175
	Inclusive® Laboratory Scanning Abutment (3-pack)* 6.0 mm	70-1135-CAM0176

	<b>Blue Light Scanner Laboratory Packs (radiolucent)</b>	
	Inclusive® Laboratory Scanning Abutment† (3-pack)* 3.3 mm	70-1135-CAM0197
	Inclusive® Laboratory Scanning Abutment† (3-pack)* 3.8 mm	70-1135-CAM0198
	Inclusive® Laboratory Scanning Abutment† (3-pack)* 4.3 mm	70-1135-CAM0199
	Inclusive® Laboratory Scanning Abutment† (3-pack)* 5.0 mm	70-1135-CAM0200
	Inclusive® Laboratory Scanning Abutment† (3-pack)* 6.0 mm	70-1135-CAM0201

†for Blue Light Scanners

(Scanning Abutments include Captured Screw.)





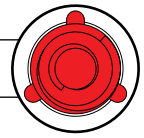





\*compatible with: Camlog® Screw-Line

# Implant components compatible with: CAMLOG® SCREW-LINE















CAMLOG is a registered trademark of Camlog Biotechnologies AG.

## BITE VERIFICATION CYLINDERS

Description (with Platform Size)		Code
	Inclusive® Bite Verification Cylinder* 3.3 mm	70-1135-CAM0042
	Inclusive® Bite Verification Cylinder* 3.8 mm	70-1135-CAM0044
	Inclusive® Bite Verification Cylinder* 4.3 mm	70-1135-CAM0046
	Inclusive® Bite Verification Cylinder* 5.0 mm	70-1135-CAM0048
	Inclusive® Bite Verification Cylinder* 6.0 mm	70-1135-CAM0050
	Inclusive® Bite Verification Cylinder, Non-Engaging* 3.3 mm	70-1135-CAM0052
	Inclusive® Bite Verification Cylinder, Non-Engaging* 3.8 mm	70-1135-CAM0054
	Inclusive® Bite Verification Cylinder, Non-Engaging* 4.3 mm	70-1135-CAM0056
	Inclusive® Bite Verification Cylinder, Non-Engaging* 5.0 mm	70-1135-CAM0058
	Inclusive® Bite Verification Cylinder, Non-Engaging* 6.0 mm	70-1135-CAM0060

*(Bite Verification Cylinders include Titanium Screw and Guide Pin.)*

## TITANIUM ABUTMENTS

	Inclusive® Titanium Abutment 4.5 mmH* 3.3 mm	70-1135-CAM0012
	Inclusive® Titanium Abutment 4.5 mmH* 3.8 mm	70-1135-CAM0014
	Inclusive® Titanium Abutment 4.5 mmH* 4.3 mm	70-1135-CAM0016
	Inclusive® Titanium Abutment 4.5 mmH* 5.0 mm	70-1135-CAM0018
	Inclusive® Titanium Abutment 4.5 mmH* 6.0 mm	70-1135-CAM0020
	Inclusive® Titanium Abutment 6 mmH* 3.3 mm	70-1135-CAM0032
	Inclusive® Titanium Abutment 6 mmH* 3.8 mm	70-1135-CAM0034
	Inclusive® Titanium Abutment 6 mmH* 4.3 mm	70-1135-CAM0036
	Inclusive® Titanium Abutment 6 mmH* 5.0 mm	70-1135-CAM0038
	Inclusive® Titanium Abutment 6 mmH* 6.0 mm	70-1135-CAM0040
	Inclusive® Titanium Abutment 4.5 mmH, Non-Engaging* 3.3 mm	70-1135-CAM0022
	Inclusive® Titanium Abutment 4.5 mmH, Non-Engaging* 3.8 mm	70-1135-CAM0024
	Inclusive® Titanium Abutment 4.5 mmH, Non-Engaging* 4.3 mm	70-1135-CAM0026
	Inclusive® Titanium Abutment 4.5 mmH, Non-Engaging* 5.0 mm	70-1135-CAM0028
	Inclusive® Titanium Abutment 4.5 mmH, Non-Engaging* 6.0 mm	70-1135-CAM0030

*(Titanium Screw sold separately; please see page 18.)*





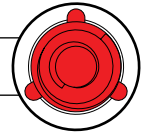





\*compatible with: Camlog® Screw-Line

# Implant components compatible with: **CAMLOG® SCREW-LINE**







CAMLOG is a registered trademark of Camlog Biotechnologies AG.

## TITANIUM ESTHETIC ABUTMENTS





	Description (with Platform Size)	Code
	Inclusive® 15° Titanium Esthetic Abutment, Anterior* 3.3 mm	70-1135-CAM0148
	Inclusive® 15° Titanium Esthetic Abutment, Anterior* 3.8 mm	70-1135-CAM0149
	Inclusive® 15° Titanium Esthetic Abutment, Anterior* 4.3 mm	70-1135-CAM0150
	Inclusive® 15° Titanium Esthetic Abutment, Posterior* 4.3 mm	70-1135-CAM0151
	Inclusive® 15° Titanium Esthetic Abutment, Posterior* 5.0 mm	70-1135-CAM0152
	Inclusive® Titanium Esthetic Abutment, Anterior* 3.3 mm	70-1135-CAM0153
	Inclusive® Titanium Esthetic Abutment, Anterior* 3.8 mm	70-1135-CAM0154
	Inclusive® Titanium Esthetic Abutment, Anterior* 4.3 mm	70-1135-CAM0155
	Inclusive® Titanium Esthetic Abutment, Posterior* 4.3 mm	70-1135-CAM0156
	Inclusive® Titanium Esthetic Abutment, Posterior* 5.0 mm	70-1135-CAM0157

*(Esthetic Abutments include Titanium Screw.)*

## TITANIUM ABUTMENT BLANKS





	Inclusive® Titanium Abutment Blank* 3.3 mm	70-1135-CAM0117
	Inclusive® Titanium Abutment Blank* 3.8 mm	70-1135-CAM0118
	Inclusive® Titanium Abutment Blank* 4.3 mm	70-1135-CAM0119
	Inclusive® Titanium Abutment Blank* 5.0 mm	70-1135-CAM0120
	Inclusive® Titanium Abutment Blank* 6.0 mm	70-1135-CAM0121

## UCLA PLASTIC ABUTMENTS

	Inclusive® UCLA Plastic Abutment, Non-Engaging* 3.3 mm	70-1135-CAM0163
	Inclusive® UCLA Plastic Abutment, Non-Engaging* 3.8 mm	70-1135-CAM0164
	Inclusive® UCLA Plastic Abutment, Non-Engaging* 4.3 mm	70-1135-CAM0165
	Inclusive® UCLA Plastic Abutment, Non-Engaging* 5.0 mm	70-1135-CAM0166
	Inclusive® UCLA Plastic Abutment, Non-Engaging* 6.0 mm	70-1135-CAM0167

*(UCLA Abutments include Titanium Screw and Guide Pin.)*

## TITANIUM SCREWS AND GUIDE PINS

	Inclusive® Titanium Screw* 3.3/3.8/4.3 mm	70-1135-CAM0124
	Inclusive® Titanium Screw (5-pack)* 3.3/3.8/4.3 mm	70-1135-CAM0125
	Inclusive® Titanium Screw* 5.0/6.0 mm	70-1135-CAM0126
	Inclusive® Titanium Screw (5-pack)* 5.0/6.0 mm	70-1135-CAM0127

\*compatible with: Camlog® Screw-Line

# Implant components compatible with: **CAMLOG® SCREW-LINE**

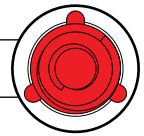

CAMLOG is a registered trademark of Camlog Biotechnologies AG.

## TITANIUM SCREWS AND GUIDE PINS



Description	Code
Inclusive® Guide Pin (5-pack)* 3.3/3.8/4.3 mm	70-1135-CAM0064
Inclusive® Guide Pin (5-pack)* 5.0/6.0 mm	70-1135-CAM0066

## MULTI-UNIT ABUTMENTS

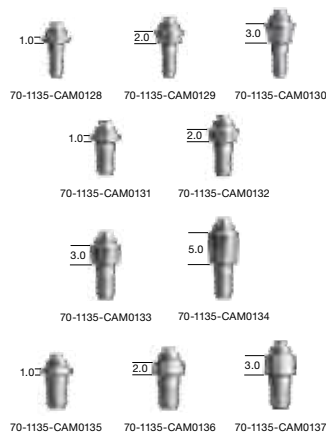

Inclusive® Multi-Unit Abutment 1 mmH* 3.8 mm	70-1135-CAM0128
Inclusive® Multi-Unit Abutment 2 mmH* 3.8 mm	70-1135-CAM0129
Inclusive® Multi-Unit Abutment 3 mmH* 3.8 mm	70-1135-CAM0130
Inclusive® Multi-Unit Abutment 1 mmH* 4.3 mm	70-1135-CAM0131
Inclusive® Multi-Unit Abutment 2 mmH* 4.3 mm	70-1135-CAM0132
Inclusive® Multi-Unit Abutment 3 mmH* 4.3 mm	70-1135-CAM0133
Inclusive® Multi-Unit Abutment 5 mmH* 4.3 mm	70-1135-CAM0134
Inclusive® Multi-Unit Abutment 1 mmH* 5.0 mm	70-1135-CAM0135
Inclusive® Multi-Unit Abutment 2 mmH* 5.0 mm	70-1135-CAM0136
Inclusive® Multi-Unit Abutment 3 mmH* 5.0 mm	70-1135-CAM0137

*(Prosthetic Screw sold separately; please see page 11.)*

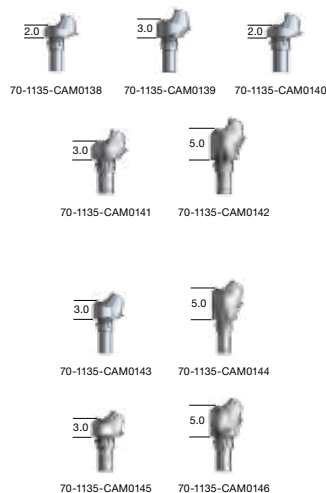

Inclusive® 17° Multi-Unit Abutment 2 mmH* 3.8 mm	70-1135-CAM0138
Inclusive® 17° Multi-Unit Abutment 3 mmH* 3.8 mm	70-1135-CAM0139
Inclusive® 17° Multi-Unit Abutment 2 mmH* 4.3 mm	70-1135-CAM0140
Inclusive® 17° Multi-Unit Abutment 3 mmH* 4.3 mm	70-1135-CAM0141
Inclusive® 17° Multi-Unit Abutment 5 mmH* 4.3 mm	70-1135-CAM0142

Inclusive® 30° Multi-Unit Abutment 3 mmH* 3.8 mm	70-1135-CAM0143
Inclusive® 30° Multi-Unit Abutment 5 mmH* 3.8 mm	70-1135-CAM0144
Inclusive® 30° Multi-Unit Abutment 3 mmH* 4.3 mm	70-1135-CAM0145
Inclusive® 30° Multi-Unit Abutment 5 mmH* 4.3 mm	70-1135-CAM0146

*(Angled Multi-Unit Abutments include Angled Abutment Screw. Prosthetic Screw sold separately; please see page 11.)*

## MULTI-UNIT TITANIUM SCREWS



Inclusive® Angled Multi-Unit Abutment Screw* 3.8/4.3 mm	70-1135-CAM0147
---	-----------------



## MULTI-UNIT ABUTMENT ACCESSORIES

**For a complete line of Multi-Unit Abutment Accessories, please see page 11.**

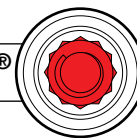

*\*compatible with: Camlog® Screw-Line*









## IMPLANT ANALOGS



Description (with Platform Size)			Code	
			Inclusive® Implant Analog (5-pack)* 3.0	70-1048-COM0014
			Inclusive® Implant Analog (5-pack)* 3.5/4.0	70-1048-COM0016
			Inclusive® Implant Analog (5-pack)* 4.5/5.0	70-1048-COM0019

## SCANNING ABUTMENTS

			<b>Clinical Use (radiopaque)</b> Inclusive® Clinical Scanning Abutment, Anterior* 3.0	70-1048-COM0124
			Inclusive® Clinical Scanning Abutment, Anterior* 3.5/4.0	70-1048-COM0125
			Inclusive® Clinical Scanning Abutment, Anterior* 4.5/5.0	70-1048-COM0126

			<b>Clinical Use (radiopaque)</b> Inclusive® Clinical Scanning Abutment, Posterior* 3.0	70-1048-COM0179
			Inclusive® Clinical Scanning Abutment, Posterior* 3.5/4.0	70-1048-COM0180
			Inclusive® Clinical Scanning Abutment, Posterior* 4.5/5.0	70-1048-COM0181





			<b>Laboratory Packs (radiolucent)</b> Inclusive® Laboratory Scanning Abutment (3-pack)* 3.0	70-1048-COM0173
			Inclusive® Laboratory Scanning Abutment (3-pack)* 3.5/4.0	70-1048-COM0174
			Inclusive® Laboratory Scanning Abutment (3-pack)* 4.5/5.0	70-1048-COM0175

			<b>Blue Light Scanner Laboratory Packs (radiolucent)</b> Inclusive® Laboratory Scanning Abutment† (3-pack)* 3.0	70-1048-COM0188
			Inclusive® Laboratory Scanning Abutment† (3-pack)* 3.5/4.0	70-1048-COM0189
			Inclusive® Laboratory Scanning Abutment† (3-pack)* 4.5/5.0	70-1048-COM0190

†for Blue Light Scanners

(Scanning Abutments include Captured Screw.)

## BITE VERIFICATION CYLINDERS

			Inclusive® Bite Verification Cylinder* 3.0	70-1048-COM0133
			Inclusive® Bite Verification Cylinder* 3.5/4.0	70-1048-COM0134
			Inclusive® Bite Verification Cylinder* 4.5/5.0	70-1048-COM0135
			Inclusive® Bite Verification Cylinder, Non-Engaging* 3.5/4.0	70-1048-COM0131
			Inclusive® Bite Verification Cylinder, Non-Engaging* 4.5/5.0	70-1048-COM0132

(Bite Verification Cylinders include Titanium Screw and Guide Pin.)

\*compatible with: Dentsply Implants Astra Tech Implant System®

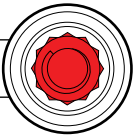

## TITANIUM ABUTMENTS

Description (with Platform Size)		Code
	Inclusive® Titanium Abutment 4.5 mmH* 3.0	70-1048-COM0089
	Inclusive® Titanium Abutment 4.5 mmH* 3.5/4.0	70-1048-COM0091
	Inclusive® Titanium Abutment 4.5 mmH* 4.5/5.0	70-1048-COM0093
	Inclusive® Titanium Abutment 6 mmH* 3.0	70-1048-COM0004
	Inclusive® Titanium Abutment 6 mmH* 3.5/4.0	70-1048-COM0005
	Inclusive® Titanium Abutment 6 mmH* 4.5/5.0	70-1048-COM0006
	Inclusive® Titanium Abutment 4.5 mmH, Non-Engaging* 3.5/4.0	70-1048-COM0097
	Inclusive® Titanium Abutment 4.5 mmH, Non-Engaging* 4.5/5.0	70-1048-COM0099

*(Titanium Screw sold separately; please see page 22.)*

## TITANIUM ESTHETIC ABUTMENTS

	Inclusive® 15° Titanium Esthetic Abutment, Anterior* 3.0	70-1048-COM0153
	Inclusive® 15° Titanium Esthetic Abutment, Anterior* 3.5/4.0	70-1048-COM0154
	Inclusive® 15° Titanium Esthetic Abutment, Anterior* 4.5/5.0	70-1048-COM0155
	Inclusive® 15° Titanium Esthetic Abutment, Posterior* 3.5/4.0	70-1048-COM0156
	Inclusive® 15° Titanium Esthetic Abutment, Posterior* 4.5/5.0	70-1048-COM0157
	Inclusive® Titanium Esthetic Abutment, Anterior* 3.0	70-1048-COM0158
	Inclusive® Titanium Esthetic Abutment, Anterior* 3.5/4.0	70-1048-COM0159
	Inclusive® Titanium Esthetic Abutment, Anterior* 4.5/5.0	70-1048-COM0160
	Inclusive® Titanium Esthetic Abutment, Posterior* 3.5/4.0	70-1048-COM0161
	Inclusive® Titanium Esthetic Abutment, Posterior* 4.5/5.0	70-1048-COM0162

*(Esthetic Abutments include Titanium Screw.)*





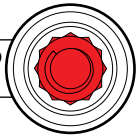

## TITANIUM ABUTMENT BLANKS

	Inclusive® Titanium Abutment Blank* 3.0	70-1048-COM0064
	Inclusive® Titanium Abutment Blank* 3.5/4.0	70-1048-COM0065
	Inclusive® Titanium Abutment Blank* 4.5/5.0	70-1048-COM0066

\*compatible with: Dentsply Implants Astra Tech Implant System®









## UCLA PLASTIC ABUTMENTS







Description (with Platform Size)			Code	
			Inclusive® UCLA Plastic Abutment* 3.0	70-1048-COM0163
70-1048-COM0163	70-1048-COM0164	70-1048-COM0165	Inclusive® UCLA Plastic Abutment* 3.5/4.0	70-1048-COM0164
			Inclusive® UCLA Plastic Abutment* 4.5/5.0	70-1048-COM0165
			Inclusive® UCLA Plastic Abutment, Non-Engaging* 3.0	70-1048-COM0166
70-1048-COM0166	70-1048-COM0167	70-1048-COM0168	Inclusive® UCLA Plastic Abutment, Non-Engaging* 3.5/4.0	70-1048-COM0167
			Inclusive® UCLA Plastic Abutment, Non-Engaging* 4.5/5.0	70-1048-COM0168

*(UCLA Abutments include Titanium Screw and Guide Pin.)*

## TITANIUM SCREWS AND GUIDE PINS

			Inclusive® Titanium Screw* 3.0	70-1048-COM0121
70-1048-COM0121	70-1048-COM0122	70-1048-COM0123	Inclusive® Titanium Screw (5-pack)* 3.0	70-1048-COM0031
70-1048-COM0031	70-1048-COM0033	70-1048-COM0036	Inclusive® Titanium Screw* 3.5/4.0	70-1048-COM0122
			Inclusive® Titanium Screw (5-pack)* 3.5/4.0	70-1048-COM0033
			Inclusive® Titanium Screw* 4.5/5.0	70-1048-COM0123
			Inclusive® Titanium Screw (5-pack)* 4.5/5.0	70-1048-COM0036
			Inclusive® Guide Pin (5-pack)* 3.0	70-1048-COM0110
70-1048-COM0110	70-1048-COM0112	70-1048-COM0114	Inclusive® Guide Pin (5-pack)* 3.5/4.0	70-1048-COM0112
			Inclusive® Guide Pin (5-pack)* 4.5/5.0	70-1048-COM0114

## MULTI-UNIT ABUTMENTS

			Inclusive® Multi-Unit Abutment 1.5 mmH* 3.5/4.0	70-1048-COM0136
70-1048-COM0136	70-1048-COM0137	70-1048-COM0138	Inclusive® Multi-Unit Abutment 2.5 mmH* 3.5/4.0	70-1048-COM0137
			Inclusive® Multi-Unit Abutment 3.5 mmH* 3.5/4.0	70-1048-COM0138
			Inclusive® Multi-Unit Abutment 1.5 mmH* 4.5/5.0	70-1048-COM0139
70-1048-COM0139	70-1048-COM0140		Inclusive® Multi-Unit Abutment 2.5 mmH* 4.5/5.0	70-1048-COM0140
			Inclusive® Multi-Unit Abutment 3.5 mmH* 4.5/5.0	70-1048-COM0141
70-1048-COM0141	70-1048-COM0142		Inclusive® Multi-Unit Abutment 4.5 mmH* 4.5/5.0	70-1048-COM0142

*(Prosthetic Screw sold separately; please see page 11.)*



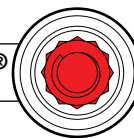

## MULTI-UNIT ABUTMENTS

Description (with Platform Size)		Code	
		Inclusive® 17° Multi-Unit Abutment 2.5 mmH* 3.5/4.0 70-1048-COM0143	70-1048-COM0143
		Inclusive® 17° Multi-Unit Abutment 3.5 mmH* 3.5/4.0 70-1048-COM0144	70-1048-COM0144
		Inclusive® 17° Multi-Unit Abutment 2.5 mmH* 4.5/5.0 70-1048-COM0145	70-1048-COM0145
		Inclusive® 17° Multi-Unit Abutment 3.5 mmH* 4.5/5.0 70-1048-COM0146	70-1048-COM0146
		Inclusive® 30° Multi-Unit Abutment 3.5 mmH* 3.5/4.0 70-1048-COM0147	70-1048-COM0147
		Inclusive® 30° Multi-Unit Abutment 4.5 mmH* 3.5/4.0 70-1048-COM0148	70-1048-COM0148
		Inclusive® 30° Multi-Unit Abutment 3.5 mmH* 4.5/5.0 70-1048-COM0149	70-1048-COM0149
		Inclusive® 30° Multi-Unit Abutment 4.5 mmH* 4.5/5.0 70-1048-COM0150	70-1048-COM0150

*(Angled Multi-Unit Abutments include Angled Abutment Screw. Prosthetic Screw sold separately; please see page 11.)*

## MULTI-UNIT TITANIUM SCREWS



Inclusive® Angled Multi-Unit Abutment Screw\* 3.5/4.0  
70-1048-COM0151



Inclusive® Angled Multi-Unit Abutment Screw\* 4.5/5.0  
70-1048-COM0152

## MULTI-UNIT ABUTMENT ACCESSORIES





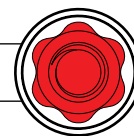







**For a complete line of Multi-Unit Abutment Accessories, please see page 11.**

# Implant components compatible with: **Keystone Dental PrimaConnex®**



PrimaConnex is a registered trademark of Keystone Dental, Inc.

## SCANNING ABUTMENTS

Description (with Platform Size)		Code
<b>Clinical Use (radiopaque)</b>		
 70-1055-COM0017	 70-1055-COM0018	Inclusive® Clinical Scanning Abutment, Anterior* SD 70-1055-COM0017
 70-1055-COM0019		Inclusive® Clinical Scanning Abutment, Anterior* RD 70-1055-COM0018
		Inclusive® Clinical Scanning Abutment, Anterior* WD 70-1055-COM0019
<b>Clinical Use (radiopaque)</b>		
 70-1055-COM0035	 70-1055-COM0036	Inclusive® Clinical Scanning Abutment, Posterior* SD 70-1055-COM0035
 70-1055-COM0037		Inclusive® Clinical Scanning Abutment, Posterior* RD 70-1055-COM0036
		Inclusive® Clinical Scanning Abutment, Posterior* WD 70-1055-COM0037
<b>Laboratory Packs (radiolucent)</b>		
 70-1055-COM0029	 70-1055-COM0030	Inclusive® Laboratory Scanning Abutment (3-pack)* SD 70-1055-COM0029
 70-1055-COM0031		Inclusive® Laboratory Scanning Abutment (3-pack)* RD 70-1055-COM0030
		Inclusive® Laboratory Scanning Abutment (3-pack)* WD 70-1055-COM0031
<b>Blue Light Scanner Laboratory Packs (radiolucent)</b>		
 70-1055-COM0044	 70-1055-COM0045	Inclusive® Laboratory Scanning Abutment† (3-pack)* SD 70-1055-COM0044
 70-1055-COM0046		Inclusive® Laboratory Scanning Abutment† (3-pack)* RD 70-1055-COM0045
		Inclusive® Laboratory Scanning Abutment† (3-pack)* WD 70-1055-COM0046



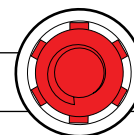

\*compatible with: Keystone Dental PrimaConnex®



# Implant components compatible with: **Neoss®**

Neoss is a registered trademark of Neoss Limited.

## SCANNING ABUTMENTS

Description (with Platform Size)		Code
<b>Clinical Use (radiopaque)</b>		
 70-1056-COM0006		Inclusive® Clinical Scanning Abutment, Anterior* 4.0 mm 70-1056-COM0006
<b>Clinical Use (radiopaque)</b>		
 70-1056-COM0012		Inclusive® Clinical Scanning Abutment, Posterior* 4.0 mm 70-1056-COM0012
<b>Laboratory Packs (radiolucent)</b>		
 70-1056-COM0010		Inclusive® Laboratory Scanning Abutment (3-pack)* 4.0 mm 70-1056-COM0010
<b>Blue Light Scanner Laboratory Packs (radiolucent)</b>		
 70-1056-COM0015		Inclusive® Laboratory Scanning Abutment† (3-pack)* 4.0 mm 70-1056-COM0015
†for Blue Light Scanners (Scanning Abutments include Captured Screw.)		



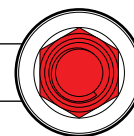

\*compatible with: Neoss®





## IMPLANT ANALOG

	Description (with Platform Size)	Code
 70-1049-COM0006	Inclusive® Implant Analog (5-pack)* RP	70-1049-COM0006



## SCANNING ABUTMENTS

 70-1049-COM0041	<b>Clinical Use (radiopaque)</b> Inclusive® Clinical Scanning Abutment, Anterior* RP	70-1049-COM0041
 70-1049-COM0067	<b>Clinical Use (radiopaque)</b> Inclusive® Clinical Scanning Abutment, Posterior* RP	70-1049-COM0067
 70-1049-COM0065	<b>Laboratory Packs (radiolucent)</b> Inclusive® Laboratory Scanning Abutment (3-pack)* RP	70-1049-COM0065
 70-1049-COM0072	<b>Blue Light Scanner Laboratory Packs (radiolucent)</b> Inclusive® Laboratory Scanning Abutment† (3-pack)* RP <i>†for Blue Light Scanners</i> <i>(Scanning Abutments include Captured Screw.)</i>	70-1049-COM0072

## BITE VERIFICATION CYLINDERS

 70-1049-COM0047	Inclusive® Bite Verification Cylinder* RP	70-1049-COM0047
 70-1049-COM0044	Inclusive® Bite Verification Cylinder, Non-Engaging* RP <i>(Bite Verification Cylinders include Titanium Screw Unigrip™ and Guide Pin Unigrip™.)</i>	70-1049-COM0044

## TITANIUM ABUTMENTS

 70-1049-COM0024	Inclusive® Titanium Abutment 4.5 mmH* RP	70-1049-COM0024
 70-1049-COM0002	Inclusive® Titanium Abutment 6 mmH* RP	70-1049-COM0002
 70-1049-COM0026	Inclusive® Titanium Abutment 4.5 mmH, Non-Engaging* RP <i>(Titanium Screw Unigrip™ sold separately; please see page 26.)</i>	70-1049-COM0026

## TITANIUM ABUTMENT BLANKS

 70-1049-COM0016	Inclusive® Titanium Abutment Blank* RP	70-1049-COM0016
--	--	-----------------

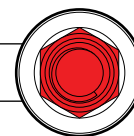

\*compatible with: Nobel Biocare Brånemark System®

# Implant components compatible with: Nobel Biocare Brånemark System®





Brånemark System and Unigrip are trademarks of the Nobel Biocare group.









## UCLA PLASTIC ABUTMENTS

	Description (with Platform Size)	Code
 70-1049-COM0063	Inclusive® UCLA Plastic Abutment* RP	70-1049-COM0063
 70-1049-COM0064	Inclusive® UCLA Plastic Abutment, Non-Engaging* RP <i>(UCLA Abutments include Titanium Screw Unigrip™ and Guide Pin Unigrip™.)</i>	70-1049-COM0064

## TITANIUM SCREWS AND GUIDE PINS (UNIGRIP™)

 70-1049-COM0040 70-1049-COM0011	Inclusive® Titanium Screw* RP	70-1049-COM0040
	Inclusive® Titanium Screw (5-pack)* RP	70-1049-COM0011
 70-1050-COM0061	Inclusive® Guide Pin Implant Level 20 mm (5-pack)* RP <i>(Unigrip™ driver required.)</i>	70-1050-COM0061

## MULTI-UNIT ABUTMENTS

 70-1049-COM0049	Inclusive® Multi-Unit Abutment 1 mmH* RP	70-1049-COM0049
 70-1049-COM0050	Inclusive® Multi-Unit Abutment 2 mmH* RP	70-1049-COM0050
 70-1049-COM0051	Inclusive® Multi-Unit Abutment 3 mmH* RP	70-1049-COM0051
 70-1049-COM0052	Inclusive® Multi-Unit Abutment 5 mmH* RP <i>(Prosthetic Screw sold separately; please see page 11.)</i>	70-1049-COM0052
 70-1049-COM0053	Inclusive® 17° Multi-Unit Abutment 2 mmH* RP	70-1049-COM0053
 70-1049-COM0054	Inclusive® 17° Multi-Unit Abutment 3 mmH* RP	70-1049-COM0054
 70-1049-COM0055	Inclusive® 17° Multi-Unit Abutment 4 mmH* RP	70-1049-COM0055
 70-1049-COM0056	Inclusive® 30° Multi-Unit Abutment 4 mmH* RP	70-1049-COM0056
 70-1049-COM0057	Inclusive® 30° Multi-Unit Abutment 5 mmH* RP <i>(Angled Multi-Unit Abutments include Angled Abutment Screw. Prosthetic Screw sold separately; please see page 11.)</i>	70-1049-COM0057

## MULTI-UNIT TITANIUM SCREWS

 70-1049-COM0058	Inclusive® Angled Multi-Unit Abutment Screw* RP	70-1049-COM0058
--	---	-----------------

## MULTI-UNIT ABUTMENT ACCESSORIES

For a complete line of Multi-Unit Abutment Accessories, please see page 11.

\*compatible with: Nobel Biocare Brånemark System®

# Implant components compatible with: Nobel Biocare NobelActive®

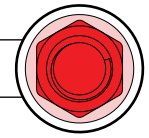

NobelActive and Unigrip are trademarks of the Nobel Biocare group.

## IMPLANT ANALOGS

Description (with Platform Size)

Code

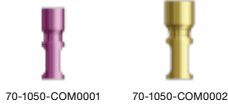

Inclusive® Implant Analog (5-pack)\* NP 70-1050-COM0001  
 Inclusive® Implant Analog (5-pack)\* RP 70-1050-COM0002

## SCANNING ABUTMENTS

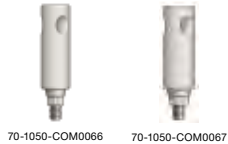

**Clinical Use (radiopaque)**  
 Inclusive® Clinical Scanning Abutment, Anterior\* NP 70-1050-COM0066  
 Inclusive® Clinical Scanning Abutment, Anterior\* RP 70-1050-COM0067



**Clinical Use (radiopaque)**  
 Inclusive® Clinical Scanning Abutment, Posterior\* NP 70-1050-COM0109  
 Inclusive® Clinical Scanning Abutment, Posterior\* RP 70-1050-COM0110



**Laboratory Packs (radiolucent)**  
 Inclusive® Laboratory Scanning Abutment (3-pack)\* NP 70-1050-COM0105  
 Inclusive® Laboratory Scanning Abutment (3-pack)\* RP 70-1050-COM0106



**Blue Light Scanner Laboratory Packs (radiolucent)**  
 Inclusive® Laboratory Scanning Abutment† (3-pack)\* NP 70-1050-COM0135  
 Inclusive® Laboratory Scanning Abutment† (3-pack)\* RP 70-1050-COM0136

†for Blue Light Scanners  
 (Scanning Abutments include Captured Screw.)

## BITE VERIFICATION CYLINDERS

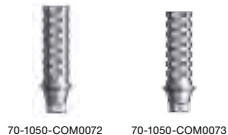

Inclusive® Bite Verification Cylinder\* NP 70-1050-COM0072  
 Inclusive® Bite Verification Cylinder\* RP 70-1050-COM0073

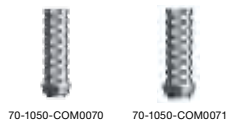

Inclusive® Bite Verification Cylinder, Non-Engaging\* NP 70-1050-COM0070  
 Inclusive® Bite Verification Cylinder, Non-Engaging\* RP 70-1050-COM0071

(Bite Verification Cylinders include Titanium Screw Unigrip™ and Guide Pin Unigrip™.)

## TITANIUM ABUTMENTS

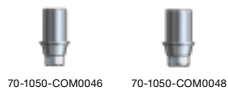

Inclusive® Titanium Abutment 4.5 mmH\* NP 70-1050-COM0046  
 Inclusive® Titanium Abutment 4.5 mmH\* RP 70-1050-COM0048

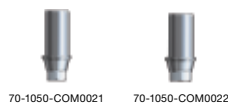

Inclusive® Titanium Abutment 6 mmH\* NP 70-1050-COM0021  
 Inclusive® Titanium Abutment 6 mmH\* RP 70-1050-COM0022

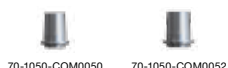

Inclusive® Titanium Abutment 4.5 mmH, Non-Engaging\* NP 70-1050-COM0050  
 Inclusive® Titanium Abutment 4.5 mmH, Non-Engaging\* RP 70-1050-COM0052

(Titanium Screw Unigrip™ sold separately; please see page 28.)



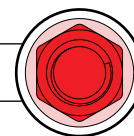

\*compatible with: Nobel Biocare NobelActive®

# Implant components compatible with: Nobel Biocare NobelActive®



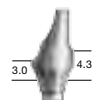
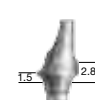

NobelActive and Unigrip are trademarks of the Nobel Biocare group.

## TITANIUM ESTHETIC ABUTMENTS





Description (with Platform Size)		Code
	Inclusive® 15° Titanium Esthetic Abutment, Anterior* NP	70-1050-COM0091
	Inclusive® 15° Titanium Esthetic Abutment, Anterior* RP	70-1050-COM0092
	Inclusive® 15° Titanium Esthetic Abutment, Posterior* RP	70-1050-COM0093
	Inclusive® Titanium Esthetic Abutment, Anterior* NP	70-1050-COM0094
	Inclusive® Titanium Esthetic Abutment, Anterior* RP	70-1050-COM0095
	Inclusive® Titanium Esthetic Abutment, Posterior* RP	70-1050-COM0096

*(Esthetic Abutments include Titanium Screw Unigrip™.)*

## TITANIUM ABUTMENT BLANKS







	Inclusive® Titanium Abutment Blank* NP	70-1050-COM0029
	Inclusive® Titanium Abutment Blank* RP	70-1050-COM0030

## UCLA PLASTIC ABUTMENTS

	Inclusive® UCLA Plastic Abutment* NP	70-1050-COM0097
	Inclusive® UCLA Plastic Abutment* RP	70-1050-COM0098
	Inclusive® UCLA Plastic Abutment, Non-Engaging* NP	70-1050-COM0099
	Inclusive® UCLA Plastic Abutment, Non-Engaging* RP	70-1050-COM0100

*(UCLA Abutments include Titanium Screw Unigrip™ and Guide Pin Unigrip™.)*

## TITANIUM SCREWS AND GUIDE PINS (UNIGRIP™)

	Inclusive® Titanium Screw* NP	70-1050-COM0064
	Inclusive® Titanium Screw (5-pack)* NP	70-1050-COM0010
	Inclusive® Titanium Screw* RP	70-1050-COM0065
	Inclusive® Titanium Screw (5-pack)* RP	70-1050-COM0011
	Inclusive® Guide Pin Implant Level 20 mm (5-pack)* NP	70-1050-COM0060
	Inclusive® Guide Pin Implant Level 20 mm (5-pack)* RP	70-1050-COM0061

*(Unigrip™ driver required.)*





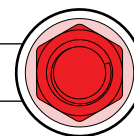











\*compatible with: Nobel Biocare NobelActive®

# Implant components compatible with: Nobel Biocare NobelActive®





NobelActive and Unigrip are trademarks of the Nobel Biocare group.

## MULTI-UNIT ABUTMENTS

		Description	Code
		Inclusive® Multi-Unit Abutment 1.5 mmH* NP	70-1050-COM0074
		Inclusive® Multi-Unit Abutment 2.5 mmH* NP	70-1050-COM0075
		Inclusive® Multi-Unit Abutment 3.5 mmH* NP	70-1050-COM0076
		Inclusive® Multi-Unit Abutment 1.5 mmH* RP	70-1050-COM0077
		Inclusive® Multi-Unit Abutment 2.5 mmH* RP	70-1050-COM0078
		Inclusive® Multi-Unit Abutment 3.5 mmH* RP	70-1050-COM0079
		Inclusive® Multi-Unit Abutment 4.5 mmH* RP	70-1050-COM0080
<i>(Prosthetic Screw sold separately; please see page 11.)</i>			
		Inclusive® 17° Multi-Unit Abutment 2.5 mmH* NP	70-1050-COM0081
		Inclusive® 17° Multi-Unit Abutment 3.5 mmH* NP	70-1050-COM0082
		Inclusive® 17° Multi-Unit Abutment 2.5 mmH* RP	70-1050-COM0083
		Inclusive® 17° Multi-Unit Abutment 3.5 mmH* RP	70-1050-COM0084
		Inclusive® 30° Multi-Unit Abutment 3.5 mmH* NP	70-1050-COM0085
		Inclusive® 30° Multi-Unit Abutment 4.5 mmH* NP	70-1050-COM0086
		Inclusive® 30° Multi-Unit Abutment 3.5 mmH* RP	70-1050-COM0087
		Inclusive® 30° Multi-Unit Abutment 4.5 mmH* RP	70-1050-COM0088
<i>(Angled Multi-Unit Abutments include Angled Abutment Screw. Prosthetic Screw sold separately; please see page 11.)</i>			

## MULTI-UNIT TITANIUM SCREWS

		Inclusive® Angled Multi-Unit Abutment Screw* NP	70-1050-COM0089
		Inclusive® Angled Multi-Unit Abutment Screw* RP	70-1050-COM0090

## MULTI-UNIT ABUTMENT ACCESSORIES

For a complete line of Multi-Unit Abutment Accessories, please see page 11.

\*compatible with: Nobel Biocare NobelActive®





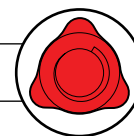

# Implant components compatible with: Nobel Biocare NobelReplace®









NobelReplace, Snappy, and Unigrip are trademarks of the Nobel Biocare group.









## IMPLANT ANALOGS

Description (with Platform Size)		Code
	Inclusive® Implant Analog (5-pack)* <b>NP</b>	70-1051-COM0002
	Inclusive® Implant Analog (5-pack)* <b>RP</b>	70-1051-COM0003
	Inclusive® Implant Analog (5-pack)* <b>WP</b>	70-1051-COM0004
	Inclusive® Implant Analog (5-pack)* <b>6.0</b>	70-1051-COM0001





## ABUTMENT ANALOGS

	Inclusive® Analog, Snappy™ Abutment 4.0 (5-pack)* <b>NP</b>	70-1051-COM0111
	Inclusive® Analog, Snappy™ Abutment 4.0 (5-pack)* <b>RP</b>	70-1051-COM0114
	Inclusive® Analog, Snappy™ Abutment 4.0 (5-pack)* <b>WP</b>	70-1051-COM0117
	Inclusive® Analog, Snappy™ Abutment 4.0 (5-pack)* <b>6.0</b>	70-1051-COM0109
	Inclusive® Analog, Snappy™ Abutment 5.5 (5-pack)* <b>NP</b>	70-1051-COM0123
	Inclusive® Analog, Snappy™ Abutment 5.5 (5-pack)* <b>RP</b>	70-1051-COM0126
	Inclusive® Analog, Snappy™ Abutment 5.5 (5-pack)* <b>WP</b>	70-1051-COM0129
	Inclusive® Analog, Snappy™ Abutment 5.5 (5-pack)* <b>6.0</b>	70-1051-COM0120

## IMPRESSION TRANSFERS

	Inclusive® Transfer Coping 3.5 mmD, Closed-Tray* <b>NP</b>	70-1051-COM0235
	Inclusive® Transfer Coping 4.3 mmD, Closed-Tray* <b>RP</b>	70-1051-COM0236
	Inclusive® Transfer Coping 5.0 mmD, Closed-Tray* <b>WP</b>	70-1051-COM0237
	Inclusive® Transfer Coping 3.5 mmD, Open-Tray* <b>NP</b>	70-1051-COM0238
	Inclusive® Transfer Coping 4.3 mmD, Open-Tray* <b>RP</b>	70-1051-COM0239
	Inclusive® Transfer Coping 5.0 mmD, Open-Tray* <b>WP</b>	70-1051-COM0240







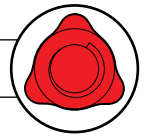





## SCANNING ABUTMENTS

Clinical Use (radiopaque)		
	Inclusive® Clinical Scanning Abutment, Anterior* <b>NP</b>	70-1051-COM0155
	Inclusive® Clinical Scanning Abutment, Anterior* <b>RP</b>	70-1051-COM0156
	Inclusive® Clinical Scanning Abutment, Anterior* <b>WP</b>	70-1051-COM0157
	Inclusive® Clinical Scanning Abutment, Anterior* <b>6.0</b>	70-1051-COM0158

\*compatible with: Nobel Biocare NobelReplace®



**SCANNING ABUTMENTS**

Description (with Platform Size)		Code
		<b>Clinical Use (radiopaque)</b>
		Inclusive® Clinical Scanning Abutment, Posterior* NP
		Inclusive® Clinical Scanning Abutment, Posterior* RP
		Inclusive® Clinical Scanning Abutment, Posterior* WP
		Inclusive® Clinical Scanning Abutment, Posterior* 6.0
		<b>Laboratory Packs (radiolucent)</b>
		Inclusive® Laboratory Scanning Abutment (3-pack)* NP
		Inclusive® Laboratory Scanning Abutment (3-pack)* RP
		Inclusive® Laboratory Scanning Abutment (3-pack)* WP
		Inclusive® Laboratory Scanning Abutment (3-pack)* 6.0
		<b>Blue Light Scanner Laboratory Packs (radiolucent)</b>
		Inclusive® Laboratory Scanning Abutment† (3-pack)* NP
		Inclusive® Laboratory Scanning Abutment† (3-pack)* RP
		Inclusive® Laboratory Scanning Abutment† (3-pack)* WP
		Inclusive® Laboratory Scanning Abutment† (3-pack)* 6.0
		<i>†for Blue Light Scanners</i>
		<i>(Scanning Abutments include Captured Screw.)</i>

**BITE VERIFICATION CYLINDERS**

		Inclusive® Bite Verification Cylinder* NP	70-1051-COM0167
		Inclusive® Bite Verification Cylinder* RP	70-1051-COM0168
		Inclusive® Bite Verification Cylinder* WP	70-1051-COM0169
		Inclusive® Bite Verification Cylinder* 6.0	70-1051-COM0170
		Inclusive® Bite Verification Cylinder, Non-Engaging* NP	70-1051-COM0163
		Inclusive® Bite Verification Cylinder, Non-Engaging* RP	70-1051-COM0164
		Inclusive® Bite Verification Cylinder, Non-Engaging* WP	70-1051-COM0165
		Inclusive® Bite Verification Cylinder, Non-Engaging* 6.0	70-1051-COM0166
		<i>(Bite Verification Cylinders include Titanium Screw Unigrip™ and Guide Pin Unigrip™.)</i>	

*\*compatible with: Nobel Biocare NobelReplace®*

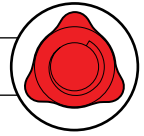

**TITANIUM ABUTMENTS**

Description (with Platform Size)		Code
	Inclusive® Titanium Abutment 4.5 mmH* NP	70-1051-COM0090
	Inclusive® Titanium Abutment 4.5 mmH* RP	70-1051-COM0092
	Inclusive® Titanium Abutment 4.5 mmH* WP	70-1051-COM0094
	Inclusive® Titanium Abutment 4.5 mmH* 6.0	70-1051-COM0088
	Inclusive® Titanium Abutment 6 mmH* NP	70-1051-COM0048
	Inclusive® Titanium Abutment 6 mmH* RP	70-1051-COM0049
	Inclusive® Titanium Abutment 6 mmH* WP	70-1051-COM0050
	Inclusive® Titanium Abutment 6 mmH* 6.0	70-1051-COM0047
	Inclusive® Titanium Abutment 4.5 mmH, Non-Engaging* NP	70-1051-COM0098
	Inclusive® Titanium Abutment 4.5 mmH, Non-Engaging* RP	70-1051-COM0100
	Inclusive® Titanium Abutment 4.5 mmH, Non-Engaging* WP	70-1051-COM0102
	Inclusive® Titanium Abutment 4.5 mmH, Non-Engaging* 6.0	70-1051-COM0096

*(Titanium Screw Unigrip™ sold separately; please see page 33.)*

**TITANIUM ESTHETIC ABUTMENTS**

	Inclusive® 15° Titanium Esthetic Abutment, Anterior* NP	70-1051-COM0190
	Inclusive® 15° Titanium Esthetic Abutment, Anterior* RP	70-1051-COM0191
	Inclusive® 15° Titanium Esthetic Abutment, Anterior* WP	70-1051-COM0192
	Inclusive® 15° Titanium Esthetic Abutment, Posterior* RP	70-1051-COM0193
	Inclusive® 15° Titanium Esthetic Abutment, Posterior* WP	70-1051-COM0194
	Inclusive® Titanium Esthetic Abutment, Anterior* NP	70-1051-COM0195
	Inclusive® Titanium Esthetic Abutment, Anterior* RP	70-1051-COM0196
	Inclusive® Titanium Esthetic Abutment, Anterior* WP	70-1051-COM0197
	Inclusive® Titanium Esthetic Abutment, Posterior* RP	70-1051-COM0198
	Inclusive® Titanium Esthetic Abutment, Posterior* WP	70-1051-COM0199
	Inclusive® Titanium Esthetic Abutment, Posterior* 6.0	70-1051-COM0200

*(Esthetic Abutments include Titanium Screw Unigrip™.)*

**TITANIUM ABUTMENT BLANKS**

	Inclusive® Titanium Abutment Blank* NP	70-1051-COM0056
	Inclusive® Titanium Abutment Blank* RP	70-1051-COM0057
	Inclusive® Titanium Abutment Blank* WP	70-1051-COM0058
	Inclusive® Titanium Abutment Blank* 6.0	70-1051-COM0055





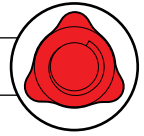







*\*compatible with: Nobel Biocare NobelReplace®*

# Implant components compatible with: Nobel Biocare NobelReplace®









NobelReplace, Snappy, and Unigrip are trademarks of the Nobel Biocare group.

## UCLA ABUTMENTS

Description (with Platform Size)		Code
	Inclusive® UCLA Plastic Abutment* NP	70-1051-COM0201
	Inclusive® UCLA Plastic Abutment* RP	70-1051-COM0202
	Inclusive® UCLA Plastic Abutment* WP	70-1051-COM0203
	Inclusive® UCLA Plastic Abutment* 6.0	70-1051-COM0204
	Inclusive® UCLA Plastic Abutment, Non-Engaging* NP	70-1051-COM0205
	Inclusive® UCLA Plastic Abutment, Non-Engaging* RP	70-1051-COM0206
	Inclusive® UCLA Plastic Abutment, Non-Engaging* WP	70-1051-COM0207
	Inclusive® UCLA Plastic Abutment, Non-Engaging* 6.0	70-1051-COM0208
	Inclusive® UCLA Gold Abutment* NP	70-1051-COM0211
	Inclusive® UCLA Gold Abutment* RP	70-1051-COM0212
	Inclusive® UCLA Gold Abutment* WP	70-1051-COM0213
	Inclusive® UCLA Gold Abutment* 6.0	70-1051-COM0214

*(UCLA Abutments include Titanium Screw Unigrip™ and Guide Pin Unigrip™.)*

## TITANIUM SCREWS AND GUIDE PINS (UNIGRIP™)

	Inclusive® Titanium Screw* NP	70-1051-COM0153
	Inclusive® Titanium Screw (5-pack)* NP	70-1051-COM0019
	Inclusive® Titanium Screw* RP/WP/6.0	70-1051-COM0154
	Inclusive® Titanium Screw (5-pack)* RP/WP/6.0	70-1051-COM0020
	Inclusive® Guide Pin Implant Level 20 mm (5-pack)* NP	70-1051-COM0142
	Inclusive® Guide Pin Implant Level 20 mm (5-pack)* RP/WP/6.0	70-1051-COM0144

*(Unigrip™ driver required.)*

\*compatible with: Nobel Biocare NobelReplace®

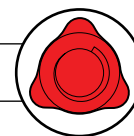

**MULTI-UNIT ABUTMENTS**

	Description	Code
	Inclusive® Multi-Unit Abutment 1 mmH* NP	70-1051-COM0171
	Inclusive® Multi-Unit Abutment 2 mmH* NP	70-1051-COM0172
	Inclusive® Multi-Unit Abutment 3 mmH* NP	70-1051-COM0173
	Inclusive® Multi-Unit Abutment 1 mmH* RP	70-1051-COM0174
	Inclusive® Multi-Unit Abutment 2 mmH* RP	70-1051-COM0175
	Inclusive® Multi-Unit Abutment 3 mmH* RP	70-1051-COM0176
	Inclusive® Multi-Unit Abutment 5 mmH* RP	70-1051-COM0177
	Inclusive® Multi-Unit Abutment 1 mmH* WP	70-1051-COM0178
	Inclusive® Multi-Unit Abutment 2 mmH* WP	70-1051-COM0179
	Inclusive® Multi-Unit Abutment 3 mmH* WP	70-1051-COM0180
	<i>(Prosthetic Screw sold separately; please see page 11.)</i>	
	Inclusive® 17° Multi-Unit Abutment 2 mmH* NP	70-1051-COM0181
	Inclusive® 17° Multi-Unit Abutment 3 mmH* NP	70-1051-COM0182
	Inclusive® 17° Multi-Unit Abutment 2 mmH* RP	70-1051-COM0183
	Inclusive® 17° Multi-Unit Abutment 3 mmH* RP	70-1051-COM0184
	Inclusive® 17° Multi-Unit Abutment 4 mmH* RP	70-1051-COM0185
	Inclusive® 30° Multi-Unit Abutment 4 mmH* RP	70-1051-COM0186
	Inclusive® 30° Multi-Unit Abutment 5 mmH* RP	70-1051-COM0187
	<i>(Angled Multi-Unit Abutments include Angled Abutment Screw. Prosthetic Screw sold separately; please see page 11.)</i>	

**MULTI-UNIT TITANIUM SCREWS**



70-1051-COM0188

Inclusive® Angled Multi-Unit Abutment Screw\* NP 70-1051-COM0188



70-1051-COM0189

Inclusive® Angled Multi-Unit Abutment Screw\* RP 70-1051-COM0189

**MULTI-UNIT ABUTMENT ACCESSORIES**



**For a complete line of Multi-Unit Abutment Accessories, please see page 11.**

# Implant components compatible with: **Straumann® Bone Level**

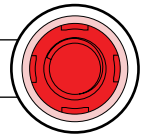







Straumann is a registered trademark of Straumann Holding AG.



## IMPLANT ANALOGS





Description (with Platform Size)		Code
	Inclusive® Implant Analog (5-pack)* <b>NC</b>	70-1052-COM0007
	Inclusive® Implant Analog (5-pack)* <b>RC</b>	70-1052-COM0008

## SCANNING ABUTMENTS

		<b>Clinical Use (radiopaque)</b>	
		Inclusive® Clinical Scanning Abutment, Anterior* <b>NC</b>	70-1052-COM0066
		Inclusive® Clinical Scanning Abutment, Anterior* <b>RC</b>	70-1052-COM0067
		<b>Clinical Use (radiopaque)</b>	
		Inclusive® Clinical Scanning Abutment, Posterior* <b>NC</b>	70-1052-COM0109
		Inclusive® Clinical Scanning Abutment, Posterior* <b>RC</b>	70-1052-COM0110
		<b>Laboratory Packs (radiolucent)</b>	
		Inclusive® Laboratory Scanning Abutment (3-pack)* <b>NC</b>	70-1052-COM0101
		Inclusive® Laboratory Scanning Abutment (3-pack)* <b>RC</b>	70-1052-COM0102
		<b>Blue Light Scanner Laboratory Packs (radiolucent)</b>	
		Inclusive® Laboratory Scanning Abutment† (3-pack)* <b>NC</b>	70-1052-COM0135
		Inclusive® Laboratory Scanning Abutment† (3-pack)* <b>RC</b>	70-1052-COM0136





*†for Blue Light Scanners*  
*(Scanning Abutments include Captured Screw.)*

## BITE VERIFICATION CYLINDERS

		Inclusive® Bite Verification Cylinder* <b>NC</b>	70-1052-COM0072
		Inclusive® Bite Verification Cylinder* <b>RC</b>	70-1052-COM0073
		Inclusive® Bite Verification Cylinder, Non-Engaging* <b>NC</b>	70-1052-COM0070
		Inclusive® Bite Verification Cylinder, Non-Engaging* <b>RC</b>	70-1052-COM0071

*(Bite Verification Cylinders include SCS Titanium Screw and SCS Guide Pin.)*

## TITANIUM ABUTMENTS

		Inclusive® Titanium Abutment 4.5 mmH* <b>NC</b>	70-1052-COM0045
		Inclusive® Titanium Abutment 4.5 mmH* <b>RC</b>	70-1052-COM0047
		Inclusive® Titanium Abutment 6 mmH* <b>NC</b>	70-1052-COM0003
		Inclusive® Titanium Abutment 6 mmH* <b>RC</b>	70-1052-COM0004

*(SCS Titanium Screw sold separately; please see page 36.)*

\*compatible with: Straumann® Bone Level

# Implant components compatible with: **Straumann® Bone Level**

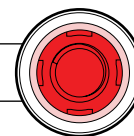

Straumann is a registered trademark of Straumann Holding AG.

## TITANIUM ABUTMENTS



Description (with Platform Size)	Code
Inclusive® Titanium Abutment 4.5 mmH, Non-Engaging* NC	70-1052-COM0049
Inclusive® Titanium Abutment 4.5 mmH, Non-Engaging* RC	70-1052-COM0051

*(SCS Titanium Screw sold separately; please see below.)*

## TITANIUM ESTHETIC ABUTMENTS

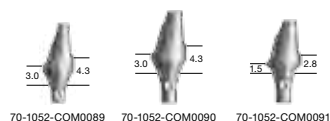

Inclusive® 15° Titanium Esthetic Abutment, Anterior* NC	70-1052-COM0089
Inclusive® 15° Titanium Esthetic Abutment, Anterior* RC	70-1052-COM0090
Inclusive® 15° Titanium Esthetic Abutment, Posterior* RC	70-1052-COM0091

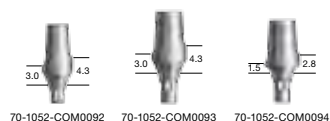

Inclusive® Titanium Esthetic Abutment, Anterior* NC	70-1052-COM0092
Inclusive® Titanium Esthetic Abutment, Anterior* RC	70-1052-COM0093
Inclusive® Titanium Esthetic Abutment, Posterior* RC	70-1052-COM0094

*(Esthetic Abutments include SCS Titanium Screw.)*

## TITANIUM ABUTMENT BLANKS



Inclusive® Titanium Abutment Blank* NC	70-1052-COM0030
Inclusive® Titanium Abutment Blank* RC	70-1052-COM0031

## UCLA PLASTIC ABUTMENTS

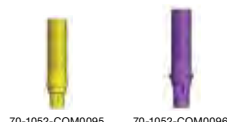

Inclusive® UCLA Plastic Abutment* NC	70-1052-COM0095
Inclusive® UCLA Plastic Abutment* RC	70-1052-COM0096

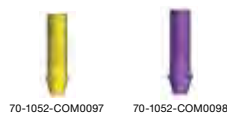

Inclusive® UCLA Plastic Abutment, Non-Engaging* NC	70-1052-COM0097
Inclusive® UCLA Plastic Abutment, Non-Engaging* RC	70-1052-COM0098

*(UCLA Abutments include SCS Titanium Screw and SCS Guide Pin.)*

## SCS TITANIUM SCREWS AND GUIDE PINS



Inclusive® Titanium Screw* NC	70-1052-COM0064
Inclusive® Titanium Screw (5-pack)* NC	70-1052-COM0020



Inclusive® Titanium Screw* RC	70-1052-COM0065
Inclusive® Titanium Screw (5-pack)* RC	70-1052-COM0021

*(SCS driver required.)*

\*compatible with: Straumann® Bone Level

# Implant components compatible with: **Straumann® Bone Level**

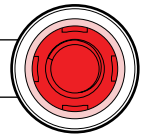

Straumann is a registered trademark of Straumann Holding AG.

## SCS TITANIUM SCREWS AND GUIDE PINS



Description (with Platform Size)	Code
Inclusive® Guide Pin (5-pack)* NC	70-1052-COM0059
Inclusive® Guide Pin (5-pack)* RC	70-1052-COM0061

(SCS driver required.)

## MULTI-UNIT ABUTMENTS



Inclusive® Multi-Unit Abutment 1.5 mmH* NC	70-1052-COM0074
Inclusive® Multi-Unit Abutment 2.5 mmH* NC	70-1052-COM0075
Inclusive® Multi-Unit Abutment 3.5 mmH* NC	70-1052-COM0076

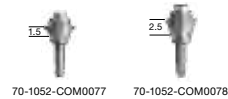

Inclusive® Multi-Unit Abutment 1.5 mmH* RC	70-1052-COM0077
Inclusive® Multi-Unit Abutment 2.5 mmH* RC	70-1052-COM0078

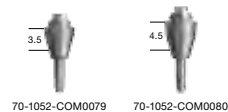

Inclusive® Multi-Unit Abutment 3.5 mmH* RC	70-1052-COM0079
Inclusive® Multi-Unit Abutment 4.5 mmH* RC	70-1052-COM0080

(Prosthetic Screw sold separately; please see page 11.)



Inclusive® 17° Multi-Unit Abutment 2.5 mmH* NC	70-1052-COM0081
Inclusive® 17° Multi-Unit Abutment 3.5 mmH* NC	70-1052-COM0082

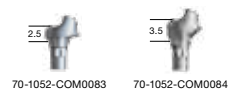

Inclusive® 17° Multi-Unit Abutment 2.5 mmH* RC	70-1052-COM0083
Inclusive® 17° Multi-Unit Abutment 3.5 mmH* RC	70-1052-COM0084

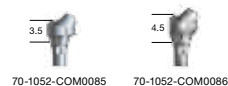

Inclusive® 30° Multi-Unit Abutment 3.5 mmH* RC	70-1052-COM0085
Inclusive® 30° Multi-Unit Abutment 4.5 mmH* RC	70-1052-COM0086

(Angled Multi-Unit Abutments include Angled Abutment Screw. Prosthetic Screw sold separately; please see page 11.)

## MULTI-UNIT TITANIUM SCREWS



Inclusive® Angled Multi-Unit Abutment Screw* NC/RC	70-1052-COM0087
--	-----------------

## MULTI-UNIT ABUTMENT ACCESSORIES

**For a complete line of Multi-Unit Abutment Accessories, please see page 11.**

\*compatible with: Straumann® Bone Level



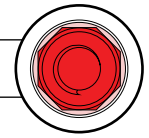

# Implant components compatible with: **Straumann® Tissue Level**







*Straumann and synOcta are registered trademarks of Straumann Holding AG.*

## IMPLANT ANALOGS

Description (with Platform Size)		Code
	Inclusive® Implant Analog (5-pack)* NN	70-1053-COM0006
	Inclusive® Implant Analog (5-pack)* RN synOcta®	70-1053-COM0007
	Inclusive® Implant Analog (5-pack)* WN synOcta®	70-1053-COM0008

## ABUTMENT ANALOGS

	Inclusive® Analog, Solid Abutment 14.3 mmL (5-pack)* RN synOcta®	70-1053-COM0020
	Inclusive® Analog, Solid Abutment 15.8 mmL (5-pack)* RN synOcta®	70-1053-COM0023
	Inclusive® Analog, Solid Abutment 17.3 mmL (5-pack)* RN synOcta®	70-1053-COM0026
	Inclusive® Analog, Solid Abutment 16 mmL (5-pack)* WN synOcta®	70-1053-COM0029
	Inclusive® Analog, Solid Abutment 17.5 mmL (5-pack)* WN synOcta®	70-1053-COM0032

## SCANNING ABUTMENTS



### *Clinical Use (radiopaque)*

Inclusive® Clinical Scanning Abutment, Posterior* RN synOcta®	70-1053-COM0043
Inclusive® Clinical Scanning Abutment, Posterior* WN synOcta®	70-1053-COM0044



### *Laboratory Packs (radiolucent)*

Inclusive® Laboratory Scanning Abutment (3-pack)* RN synOcta®	70-1053-COM0041
Inclusive® Laboratory Scanning Abutment (3-pack)* WN synOcta®	70-1053-COM0042



### *Blue Light Scanner Laboratory Packs (radiolucent)*

Inclusive® Laboratory Scanning Abutment† (3-pack)* RN synOcta®	70-1053-COM0087
Inclusive® Laboratory Scanning Abutment† (3-pack)* WN synOcta®	70-1053-COM0088

*†for Blue Light Scanners (Scanning Abutments include Captured Screw.)*

## TITANIUM ABUTMENTS



Inclusive® Titanium Abutment 4.5 mmH, Non-Engaging* RN synOcta®	70-1053-COM0057
Inclusive® Titanium Abutment 4.5 mmH, Non-Engaging* WN synOcta®	70-1053-COM0058

## UCLA ABUTMENTS

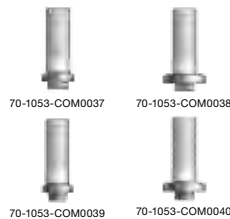

Inclusive® UCLA Gold Abutment* RN synOcta®	70-1053-COM0037
Inclusive® UCLA Gold Abutment* WN synOcta®	70-1053-COM0038
Inclusive® UCLA Gold Abutment, Non-Engaging* RN synOcta®	70-1053-COM0039
Inclusive® UCLA Gold Abutment, Non-Engaging* WN synOcta®	70-1053-COM0040

## SCS TITANIUM SCREWS

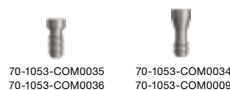

*(SCS driver required)*

Inclusive® Titanium Occlusal Screw* NN	70-1053-COM0035
Inclusive® Titanium Occlusal Screw (5-pack)* NN	70-1053-COM0036
Inclusive® Titanium Basal Screw* RN/WN synOcta®	70-1053-COM0034
Inclusive® Titanium Basal Screw (5-pack)* RN/WN synOcta®	70-1053-COM0009

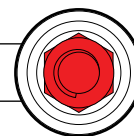

**\*\*compatible with: Straumann® Tissue Level**

# Implant components compatible with: Zimmer Dental Screw-Vent®









Screw-Vent is a registered trademark of Zimmer Dental Inc.



## IMPLANT ANALOGS



Description (with Platform Size)			Code
			
70-1054-COM0010	70-1054-COM0011	70-1054-COM0012	
Inclusive® Implant Analog (5-pack)* 3.5 mm			70-1054-COM0010
Inclusive® Implant Analog (5-pack)* 4.5 mm			70-1054-COM0011
Inclusive® Implant Analog (5-pack)* 5.7 mm			70-1054-COM0012

## SCANNING ABUTMENTS

Clinical Use (radiopaque)			
			
70-1054-COM0088	70-1054-COM0089	70-1054-COM0090	
Inclusive® Clinical Scanning Abutment, Anterior* 3.5 mm			70-1054-COM0088
Inclusive® Clinical Scanning Abutment, Anterior* 4.5 mm			70-1054-COM0089
Inclusive® Clinical Scanning Abutment, Anterior* 5.7 mm			70-1054-COM0090

Clinical Use (radiopaque)			
			
70-1054-COM0115	70-1054-COM0116	70-1054-COM0117	
Inclusive® Clinical Scanning Abutment, Posterior* 3.5 mm			70-1054-COM0115
Inclusive® Clinical Scanning Abutment, Posterior* 4.5 mm			70-1054-COM0116
Inclusive® Clinical Scanning Abutment, Posterior* 5.7 mm			70-1054-COM0117



Laboratory Packs (radiolucent)			
			
70-1054-COM0106	70-1054-COM0107	70-1054-COM0108	
Inclusive® Laboratory Scanning Abutment (3-pack)* 3.5 mm			70-1054-COM0106
Inclusive® Laboratory Scanning Abutment (3-pack)* 4.5 mm			70-1054-COM0107
Inclusive® Laboratory Scanning Abutment (3-pack)* 5.7 mm			70-1054-COM0108



Blue Light Scanner Laboratory Packs (radiolucent)			
			
70-1054-COM0151	70-1054-COM0152	70-1054-COM0153	
Inclusive® Laboratory Scanning Abutment† (3-pack)* 3.5 mm			70-1054-COM0151
Inclusive® Laboratory Scanning Abutment† (3-pack)* 4.5 mm			70-1054-COM0152
Inclusive® Laboratory Scanning Abutment† (3-pack)* 5.7 mm			70-1054-COM0153

†for Blue Light Scanners

(Scanning Abutments include Captured Screw.)

## BITE VERIFICATION CYLINDERS

			
70-1054-COM0097	70-1054-COM0098	70-1054-COM0099	
Inclusive® Bite Verification Cylinder* 3.5 mm			70-1054-COM0097
Inclusive® Bite Verification Cylinder* 4.5 mm			70-1054-COM0098
Inclusive® Bite Verification Cylinder* 5.7 mm			70-1054-COM0099

			
70-1054-COM0094	70-1054-COM0095	70-1054-COM0096	
Inclusive® Bite Verification Cylinder, Non-Engaging* 3.5 mm			70-1054-COM0094
Inclusive® Bite Verification Cylinder, Non-Engaging* 4.5 mm			70-1054-COM0095
Inclusive® Bite Verification Cylinder, Non-Engaging* 5.7 mm			70-1054-COM0096

(Bite Verification Cylinders include Titanium Screw and Guide Pin.)





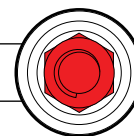



\*compatible with: Zimmer Dental Screw-Vent®

# Implant components compatible with: Zimmer Dental Screw-Vent®





Screw-Vent is a registered trademark of Zimmer Dental Inc.

## TITANIUM ABUTMENTS







Description (with Platform Size)			Code
			70-1054-COM0063
			70-1054-COM0065
			70-1054-COM0067
			70-1054-COM0004
			70-1054-COM0005
			70-1054-COM0006
			70-1054-COM0069
			70-1054-COM0071
			70-1054-COM0073

*(Titanium Screw sold separately; please see below.)*

## TITANIUM ABUTMENT BLANKS



			70-1054-COM0041
			70-1054-COM0042
			70-1054-COM0043

## UCLA PLASTIC ABUTMENTS

			70-1054-COM0100
			70-1054-COM0101
			70-1054-COM0102
			70-1054-COM0103
			70-1054-COM0104
			70-1054-COM0105

*(UCLA Abutments include Titanium Screw and Guide Pin.)*

## TITANIUM SCREWS AND GUIDE PINS

	Inclusive® Titanium Screw* 3.5/4.5/5.7 mm	70-1054-COM0048
	Inclusive® Titanium Screw (5-pack)* 3.5/4.5/5.7 mm	70-1054-COM0022
	Inclusive® Guide Pin (5-pack)* 3.5/4.5/5.7 mm	70-1054-COM0084

\*compatible with: Zimmer Dental Screw-Vent®

---

# INCLUSIVE® Prosthetic Kit

---

All instruments associated with the Inclusive Tapered Implant System are machined from high-quality, corrosion-resistant, surgical stainless steel, and feature standard connectivity.

Description	Code
Inclusive® Tapered Implant Prosthetic Kit	70-1071-PRS0001



---

## **Features and Benefits**

The Inclusive Tapered Implant Prosthetic Kit allows the clinician to easily organize, store, and transport the prosthetic tooling of the Inclusive Tapered Implant System. The autoclavable kit is designed specifically for restorative doctors, to help simplify prosthetic procedures and instrument sterilization.

## **Sterilization**

It is recommended that the prosthetic kit be steam-sterilized for twenty (20) minutes at 132°C/270°F minimum.

## **General Cleaning Tips:**

- Observe universal precautions for the handling of contaminated or biohazardous materials.
- Clean promptly after each use, to prevent biological fluids and tissues from drying on the instruments.
- When applicable, disassemble parts and instruments prior to cleaning.
- Do not rely solely on automatic cleaning. Thorough manual cleaning is recommended.
- Preliminary cleaning should consist of wiping parts, soaking them in a lukewarm enzymatic solution for a minimum of twenty (20) minutes, and rinsing them with running water.
- Routine cleaning should consist of (a) washing parts using a broad spectrum cleaning solution, followed by thorough rinsing and drying; and (b) sonicate parts fully submerged in cleaning solution for at least ten (10) minutes, preferably at 45-50 kHz, followed by thorough rinsing and drying.
- Dry promptly and completely to avoid oxidation.

# INCLUSIVE® Laboratory Scanning Abutment Kit

## SCANNING ABUTMENT KIT

Description	Code
Inclusive® Laboratory Scanning Abutment Kit	70-1073-PRA0039
Inclusive® Scanning Abutment Kit for Blue Light Scanners	70-1073-PRA0061

The Inclusive® Laboratory Scanning Abutment Kit, available for both traditional red-light and newer blue-light scanners, enables dental labs to maximize efficiency and value while taking advantage of Glidewell Laboratories' precise implant milling solutions.



Each kit contains a 3-pack of scanning abutments for the following implant platforms (99 scanning abutments in all):

- Biomet 3i™ Certain®  
3.4 mm, 4.1 mm, 5.0 mm, 6.0 mm
- Camlog® Screw-Line  
3.3 mm, 3.8 mm, 4.3 mm, 5.0 mm, 6.0 mm
- Dentsply Implants Ankylos® C/X  
A/B/C/D
- Dentsply Implants Astra Tech Implant System®  
3.0 (X-Small), 3.5/4.0 (Small), 4.5/5.0 (Large)
- Hiossen® HG System  
Mini, Standard
- Keystone Dental PrimaConnex®  
SD, RD, WD
- Neoss®  
4.0 mm
- Nobel Biocare Brånemark System®  
RP
- Nobel Biocare NobelActive®  
NP, RP
- Nobel Biocare NobelReplace®  
NP, RP, WP, 6.0 mm
- Straumann® Bone Level  
NC, RC
- Straumann® Tissue Level  
RN synOcta®, WN synOcta®
- Zimmer Dental Screw-Vent®  
3.5 mm, 4.5 mm, 5.7 mm

## Features and Benefits

Paired with the powerful 3Shape AbutmentDesigner™ module, the Inclusive Laboratory Scanning Abutment Kit can be used to scan and design custom implant abutments for 33 different restorative platforms spanning 13 major implant systems. Included with the kit is the Glidewell Digital Abutment Library, which provides custom morphology for the design of Inclusive-brand custom implant abutments, available in titanium and zirconia with a titanium base.

# Parts Index

CODE	DESCRIPTION	PAGE	CODE	DESCRIPTION	PAGE
<b>ANALOGS</b>					
<b>(BIOMET 3i™ Certain®)</b>					
70-1047-COM0013	Implant Analog (5/pk) 3.4 mm	12	70-1047-COM0131	Bite Verification Cylinder 4.1 mm	13
70-1047-COM0014	Implant Analog (5/pk) 4.1 mm	12	70-1047-COM0132	Bite Verification Cylinder 5.0 mm	13
70-1047-COM0015	Implant Analog (5/pk) 5.0 mm	12	70-1047-COM0133	Bite Verification Cylinder 6.0 mm	13
70-1047-COM0016	Implant Analog (5/pk) 6.0 mm	12	70-1047-COM0126	Bite Verification Cylinder, Non-Engag 3.4 mm	13
<b>(CAMLOG® SCREW-LINE)</b>					
70-1135-CAM0068	Implant Analog (5/pk) 3.3 mm	16	70-1047-COM0127	Bite Verification Cylinder, Non-Engag 4.1 mm	13
70-1135-CAM0070	Implant Analog (5/pk) 3.8 mm	16	70-1047-COM0128	Bite Verification Cylinder, Non-Engag 5.0 mm	13
70-1135-CAM0072	Implant Analog (5/pk) 4.3 mm	16	70-1047-COM0129	Bite Verification Cylinder, Non-Engag 6.0 mm	13
70-1135-CAM0074	Implant Analog (5/pk) 5.0 mm	16	<b>(CAMLOG® SCREW-LINE)</b>		
70-1135-CAM0076	Implant Analog (5/pk) 6.0 mm	16	70-1135-CAM0042	Bite Verification Cylinder 3.3 mm	17
<b>(DENTSPLY Implants ASTRA TECH Implant System®)</b>					
70-1048-COM0014	Implant Analog (5/pk) 3.0	20	70-1135-CAM0044	Bite Verification Cylinder 3.8 mm	17
70-1048-COM0016	Implant Analog (5/pk) 3.5/4.0	20	70-1135-CAM0046	Bite Verification Cylinder 4.3 mm	17
70-1048-COM0019	Implant Analog (5/pk) 4.5/5.0	20	70-1135-CAM0048	Bite Verification Cylinder 5.0 mm	17
<b>(Inclusive® Tapered Implant System)</b>					
70-1072-PRC0055	Implant Analog 3.0 mmP	6	70-1135-CAM0050	Bite Verification Cylinder 6.0 mm	17
70-1072-PRC0015	Implant Analog 3.5 mmP	6	70-1135-CAM0052	Bite Verification Cylinder, Non-Engag 3.3 mm	17
70-1072-PRC0017	Implant Analog 4.5 mmP	6	70-1135-CAM0054	Bite Verification Cylinder, Non-Engag 3.8 mm	17
<b>(Nobel Biocare Brånemark System®)</b>					
70-1049-COM0006	Implant Analog (5/pk) RP	25	70-1135-CAM0056	Bite Verification Cylinder, Non-Engag 4.3 mm	17
<b>(NobelActive®)</b>					
70-1050-COM0001	Implant Analog (5/pk) NP	27	70-1135-CAM0058	Bite Verification Cylinder, Non-Engag 5.0 mm	17
70-1050-COM0002	Implant Analog (5/pk) RP	27	70-1135-CAM0060	Bite Verification Cylinder, Non-Engag 6.0 mm	17
<b>(NobelReplace®)</b>					
70-1051-COM0109	Analog, Snappy Abutment 4.0 (5/pk) 6.0	30	<b>(DENTSPLY Implants ASTRA TECH Implant System®)</b>		
70-1051-COM0111	Analog, Snappy Abutment 4.0 (5/pk) NP	30	70-1048-COM0133	Bite Verification Cylinder 3.0	20
70-1051-COM0114	Analog, Snappy Abutment 4.0 (5/pk) RP	30	70-1048-COM0134	Bite Verification Cylinder 3.5/4.0	20
70-1051-COM0117	Analog, Snappy Abutment 4.0 (5/pk) WP	30	70-1048-COM0135	Bite Verification Cylinder 4.5/5.0	20
70-1051-COM0001	Implant Analog (5/pk) 6.0	30	70-1048-COM0131	Bite Verification Cylinder, Non-Engag 3.5/4.0	20
70-1051-COM0002	Implant Analog (5/pk) NP	30	70-1048-COM0132	Bite Verification Cylinder, Non-Engag 4.5/5.0	20
70-1051-COM0003	Implant Analog (5/pk) RP	30	<b>(Nobel Biocare Brånemark System®)</b>		
70-1051-COM0004	Implant Analog (5/pk) WP	30	70-1049-COM0047	Bite Verification Cylinder RP	25
70-1051-COM0120	Analog, Snappy Abutment 5.5 (5/pk) 6.0	30	70-1049-COM0044	Bite Verification Cylinder, Non-Engag RP	25
70-1051-COM0123	Analog, Snappy Abutment 5.5 (5/pk) NP	30	<b>(NobelActive®)</b>		
70-1051-COM0126	Analog, Snappy Abutment 5.5 (5/pk) RP	30	70-1050-COM0072	Bite Verification Cylinder NP	27
70-1051-COM0129	Analog, Snappy Abutment 5.5 (5/pk) WP	30	70-1050-COM0073	Bite Verification Cylinder RP	27
<b>(Straumann® Bone Level)</b>					
70-1052-COM0007	Implant Analog (5/pk) NC	35	70-1050-COM0070	Bite Verification Cylinder, Non-Engag NP	27
70-1052-COM0008	Implant Analog (5/pk) RC	35	70-1050-COM0071	Bite Verification Cylinder, Non-Engag RP	27
<b>(Straumann® Tissue Level)</b>					
70-1053-COM0020	Analog, Solid Abutment 14.3 mmL (5/pk) RN synOcta	38	<b>(NobelReplace®)</b>		
70-1053-COM0023	Analog, Solid Abutment 15.8 mmL (5/pk) RN synOcta	38	70-1051-COM0170	Bite Verification Cylinder 6.0	31
70-1053-COM0026	Analog, Solid Abutment 17.3 mmL (5/pk) RN synOcta	38	70-1051-COM0167	Bite Verification Cylinder NP	31
70-1053-COM0006	Implant Analog (5/pk) NN	38	70-1051-COM0168	Bite Verification Cylinder RP	31
70-1053-COM0007	Implant Analog (5/pk) RN synOcta	38	70-1051-COM0169	Bite Verification Cylinder WP	31
70-1053-COM0008	Implant Analog (5/pk) WN synOcta	38	70-1051-COM0166	Bite Verification Cylinder, Non-Engag 6.0	31
70-1053-COM0029	Analog, Solid Abutment 16 mmL (5/pk) WN synOcta	38	70-1051-COM0163	Bite Verification Cylinder, Non-Engag NP	31
70-1053-COM0032	Analog, Solid Abutment 17.5 mmL (5/pk) WN synOcta	38	70-1051-COM0164	Bite Verification Cylinder, Non-Engag RP	31
<b>(Zimmer Dental Screw-Vent®)</b>					
70-1054-COM0010	Implant Analog (5/pk) 3.5 mm	39	70-1051-COM0165	Bite Verification Cylinder, Non-Engag WP	31
70-1054-COM0011	Implant Analog (5/pk) 4.5 mm	39	<b>(Straumann® Bone Level)</b>		
70-1054-COM0012	Implant Analog (5/pk) 5.7 mm	39	70-1052-COM0072	Bite Verification Cylinder NC	35
<b>BITE VERIFICATION CYLINDERS</b>					
<b>(BIOMET 3i™ Certain®)</b>					
70-1047-COM0130	Bite Verification Cylinder 3.4 mm	13	70-1052-COM0073	Bite Verification Cylinder RC	35
<b>IMPRESSION TRANSFERS</b>					
<b>(Inclusive® Tapered Implant System)</b>					
70-1072-PRC0051	Transfer Coping, Closed-Tray, 3.0 mmP x 3.2 mmD	6	70-1052-COM0070	Bite Verification Cylinder, Non-Engag NC	35
70-1072-PRC0053	Transfer Coping, Closed-Tray, 3.0 mmP x 3.7 mmD	6	70-1052-COM0071	Bite Verification Cylinder, Non-Engag RC	35
<b>(Zimmer Dental Screw-Vent®)</b>					
70-1054-COM0097	Bite Verification Cylinder 3.5 mm	39			
70-1054-COM0098	Bite Verification Cylinder 4.5 mm	39			
70-1054-COM0099	Bite Verification Cylinder 5.7 mm	39			
70-1054-COM0094	Bite Verification Cylinder, Non-Engag 3.5 mm	39			
70-1054-COM0095	Bite Verification Cylinder, Non-Engag 4.5 mm	39			
70-1054-COM0096	Bite Verification Cylinder, Non-Engag 5.7 mm	39			



# Parts Index

CODE	DESCRIPTION	PAGE	CODE	DESCRIPTION	PAGE
70-1072-PRC0007	Transfer Coping, Closed-Tray, 3.5 mmP x 3.5 mmD	6	70-1135-CAM0144	30° Multi-Unit Abutment 5 mmH 3.8 mm	19
70-1072-PRC0009	Transfer Coping, Closed-Tray, 3.5 mmP x 4.7 mmD	6	70-1135-CAM0146	30° Multi-Unit Abutment 5 mmH 4.3 mm	19
70-1072-PRC0011	Transfer Coping, Closed-Tray, 4.5 mmP x 4.5 mmD	6	<b>(DENTSPLY Implants ASTRA TECH Implant System®)</b>		
70-1072-PRC0013	Transfer Coping, Closed-Tray, 4.5 mmP x 5.7 mmD	6	70-1048-COM0151	Angled Multi-Unit Abutment Screw 3.5/4.0	23
70-1072-PRC0052	Transfer Coping, Open-Tray, 3.0 mmP x 3.2 mmD	6	70-1048-COM0152	Angled Multi-Unit Abutment Screw 4.5/5.0	23
70-1072-PRC0054	Transfer Coping, Open-Tray, 3.0 mmP x 3.7 mmD	6	70-1048-COM0136	Multi-Unit Abutment 1.5 mmH 3.5/4.0	22
70-1072-PRC0006	Transfer Coping, Open-Tray, 3.5 mmP x 3.5 mmD	6	70-1048-COM0139	Multi-Unit Abutment 1.5 mmH 4.5/5.0	22
70-1072-PRC0008	Transfer Coping, Open-Tray, 3.5 mmP x 4.7 mmD	6	70-1048-COM0137	Multi-Unit Abutment 2.5 mmH 3.5/4.0	22
70-1072-PRC0010	Transfer Coping, Open-Tray, 4.5 mmP x 4.5 mmD	6	70-1048-COM0140	Multi-Unit Abutment 2.5 mmH 4.5/5.0	22
70-1072-PRC0012	Transfer Coping, Open-Tray, 4.5 mmP x 5.7 mmD	6	70-1048-COM0138	Multi-Unit Abutment 3.5 mmH 3.5/4.0	22
<b>(NobelReplace®)</b>			70-1048-COM0141	Multi-Unit Abutment 3.5 mmH 4.5/5.0	22
70-1051-COM0235	Transfer Coping, Closed-Tray, NP	30	70-1048-COM0142	Multi-Unit Abutment 4.5 mmH 4.5/5.0	22
70-1051-COM0236	Transfer Coping, Closed-Tray, RP	30	70-1048-COM0143	17° Multi-Unit Abutment 2.5 mmH 3.5/4.0	23
70-1051-COM0237	Transfer Coping, Closed-Tray, WP	30	70-1048-COM0145	17° Multi-Unit Abutment 2.5 mmH 4.5/5.0	23
70-1051-COM0238	Transfer Coping, Open-Tray, NP	30	70-1048-COM0144	17° Multi-Unit Abutment 3.5 mmH 3.5/4.0	23
70-1051-COM0239	Transfer Coping, Open-Tray, RP	30	70-1048-COM0146	17° Multi-Unit Abutment 3.5 mmH 4.5/5.0	23
70-1051-COM0240	Transfer Coping, Open-Tray, WP	30	70-1048-COM0147	30° Multi-Unit Abutment 3.5 mmH 3.5/4.0	23
<b>MULTI-UNIT ABUTMENTS</b>			70-1048-COM0149	30° Multi-Unit Abutment 3.5 mmH 4.5/5.0	23
<b>(BIOMET 3i™ Certain®)</b>			70-1048-COM0148	30° Multi-Unit Abutment 4.5 mmH 3.5/4.0	23
70-1047-COM0152	Angled Multi-Unit Abutment Screw 3.4/4.1/5.0/6.0 mm	15	70-1048-COM0150	30° Multi-Unit Abutment 4.5 mmH 4.5/5.0	23
70-1047-COM0134	Multi-Unit Abutment 1 mmH 3.4 mm	15	<b>(Inclusive® Tapered Implant System)</b>		
70-1047-COM0137	Multi-Unit Abutment 1 mmH 4.1 mm	15	70-1074-PRS0031	Angled Multi-Unit Abutment Screw	10
70-1047-COM0141	Multi-Unit Abutment 1 mmH 5.0 mm	15	70-1074-PRS0040	Multi-Unit Abutment 3.0 mmP x 1.5 mmH	10
70-1047-COM0135	Multi-Unit Abutment 2 mmH 3.4 mm	15	70-1074-PRS0041	Multi-Unit Abutment 3.0 mmP x 2.5 mmH	10
70-1047-COM0138	Multi-Unit Abutment 2 mmH 4.1 mm	15	70-1074-PRS0042	Multi-Unit Abutment 3.0 mmP x 3.5 mmH	10
70-1047-COM0142	Multi-Unit Abutment 2 mmH 5.0 mm	15	70-1074-PRS0009	Multi-Unit Abutment 3.5 mmP x 1 mmH	10
70-1047-COM0136	Multi-Unit Abutment 3 mmH 3.4 mm	15	70-1074-PRS0010	Multi-Unit Abutment 3.5 mmP x 2 mmH	10
70-1047-COM0139	Multi-Unit Abutment 3 mmH 4.1 mm	15	70-1074-PRS0011	Multi-Unit Abutment 4.5 mmP x 1 mmH	10
70-1047-COM0143	Multi-Unit Abutment 3 mmH 5.0 mm	15	70-1074-PRS0012	Multi-Unit Abutment 4.5 mmP x 2 mmH	10
70-1047-COM0140	Multi-Unit Abutment 5 mmH 4.1 mm	15	70-1074-PRS0013	Multi-Unit Abutment 4.5 mmP x 3 mmH	10
70-1047-COM0144	17° Multi-Unit Abutment 2 mmH 3.4 mm	15	70-1074-PRS0014	Multi-Unit Abutment 4.5 mmP x 5 mmH	10
70-1047-COM0146	17° Multi-Unit Abutment 2 mmH 4.1 mm	15	70-1074-PRS0001	17° Multi-Unit Abutment 3.5 mmP x 2 mmH	10
70-1047-COM0148	17° Multi-Unit Abutment 2 mmH 5.0 mm	15	70-1074-PRS0002	17° Multi-Unit Abutment 3.5 mmP x 3 mmH	10
70-1047-COM0145	17° Multi-Unit Abutment 3 mmH 3.4 mm	15	70-1074-PRS0003	17° Multi-Unit Abutment 4.5 mmP x 2 mmH	10
70-1047-COM0147	17° Multi-Unit Abutment 3 mmH 4.1 mm	15	70-1074-PRS0004	17° Multi-Unit Abutment 4.5 mmP x 3 mmH	10
70-1047-COM0149	17° Multi-Unit Abutment 3 mmH 5.0 mm	15	70-1074-PRS0005	17° Multi-Unit Abutment 4.5 mmP x 5 mmH	10
70-1047-COM0150	30° Multi-Unit Abutment 4 mmH 4.1 mm	15	70-1074-PRS0006	30° Multi-Unit Abutment 3.5 mmP x 3 mmH	10
70-1047-COM0151	30° Multi-Unit Abutment 5 mmH 4.1 mm	15	70-1074-PRS0007	30° Multi-Unit Abutment 4.5 mmP x 3 mmH	10
<b>(CAMLOG® SCREW-LINE)</b>			70-1074-PRS0008	30° Multi-Unit Abutment 4.5 mmP x 5 mmH	10
70-1135-CAM0147	Angled Multi-Unit Abutment Screw 3.8/4.3 mm	19	<b>(Nobel Biocare Brånemark System®)</b>		
70-1135-CAM0128	Multi-Unit Abutment 1 mmH 3.8 mm	19	70-1049-COM0058	Angled Multi-Unit Abutment Screw RP	26
70-1135-CAM0131	Multi-Unit Abutment 1 mmH 4.3 mm	19	70-1049-COM0049	Multi-Unit Abutment 1 mmH RP	26
70-1135-CAM0135	Multi-Unit Abutment 1 mmH 5.0 mm	19	70-1049-COM0050	Multi-Unit Abutment 2 mmH RP	26
70-1135-CAM0129	Multi-Unit Abutment 2 mmH 3.8 mm	19	70-1049-COM0051	Multi-Unit Abutment 3 mmH RP	26
70-1135-CAM0132	Multi-Unit Abutment 2 mmH 4.3 mm	19	70-1049-COM0052	Multi-Unit Abutment 5 mmH RP	26
70-1135-CAM0136	Multi-Unit Abutment 2 mmH 5.0 mm	19	70-1049-COM0053	17° Multi-Unit Abutment 2 mmH RP	26
70-1135-CAM0130	Multi-Unit Abutment 3 mmH 3.8 mm	19	70-1049-COM0054	17° Multi-Unit Abutment 3 mmH RP	26
70-1135-CAM0133	Multi-Unit Abutment 3 mmH 4.3 mm	19	70-1049-COM0055	17° Multi-Unit Abutment 4 mmH RP	26
70-1135-CAM0137	Multi-Unit Abutment 3 mmH 5.0 mm	19	70-1049-COM0056	30° Multi-Unit Abutment 4 mmH RP	26
70-1135-CAM0134	Multi-Unit Abutment 5 mmH 4.3 mm	19	70-1049-COM0057	30° Multi-Unit Abutment 5 mmH RP	26
70-1135-CAM0138	17° Multi-Unit Abutment 2 mmH 3.8 mm	19	<b>(NobelActive®)</b>		
70-1135-CAM0140	17° Multi-Unit Abutment 2 mmH 4.3 mm	19	70-1050-COM0089	Angled Multi-Unit Abutment Screw NP	29
70-1135-CAM0139	17° Multi-Unit Abutment 3 mmH 3.8 mm	19	70-1050-COM0090	Angled Multi-Unit Abutment Screw RP	29
70-1135-CAM0141	17° Multi-Unit Abutment 3 mmH 4.3 mm	19	70-1050-COM0074	Multi-Unit Abutment 1.5 mmH NP	29
70-1135-CAM0142	17° Multi-Unit Abutment 5 mmH 4.3 mm	19	70-1050-COM0077	Multi-Unit Abutment 1.5 mmH RP	29
70-1135-CAM0143	30° Multi-Unit Abutment 3 mmH 3.8 mm	19	70-1050-COM0075	Multi-Unit Abutment 2.5 mmH NP	29
70-1135-CAM0145	30° Multi-Unit Abutment 3 mmH 4.3 mm	19	70-1050-COM0078	Multi-Unit Abutment 2.5 mmH RP	29
			70-1050-COM0076	Multi-Unit Abutment 3.5 mmH NP	29

# Parts Index

CODE	DESCRIPTION	PAGE	CODE	DESCRIPTION	PAGE
70-1050-COM0079	Multi-Unit Abutment 3.5 mmH RP	29	70-1074-PRS0035	Multi-Unit Guide Pin .048" Hex	11
70-1050-COM0080	Multi-Unit Abutment 4.5 mmH RP	29	70-1074-PRS0061	Multi-Unit Guide Pin .050" Hex	11
70-1050-COM0081	17° Multi-Unit Abutment 2.5 mmH NP	29	70-1074-PRS0036	Multi-Unit Guide Pin 1.0 mm Hex	11
70-1050-COM0083	17° Multi-Unit Abutment 2.5 mmH RP	29	70-1074-PRS0037	Multi-Unit Guide Pin SCS	11
70-1050-COM0082	17° Multi-Unit Abutment 3.5 mmH NP	29	70-1074-PRS0019	Multi-Unit Guide Pin - Unigrip	11
70-1050-COM0084	17° Multi-Unit Abutment 3.5 mmH RP	29	70-1074-PRS0030	Multi-Unit Gold/Plastic Coping	11
70-1050-COM0085	30° Multi-Unit Abutment 3.5 mmH NP	29	70-1074-PRS0018	Multi-Unit Gold Bar Coping	11
70-1050-COM0087	30° Multi-Unit Abutment 3.5 mmH RP	29	70-1074-PRS0022	Multi-Unit Impression Coping, Open-Tray - Unigrip	11
70-1050-COM0086	30° Multi-Unit Abutment 4.5 mmH NP	29	70-1074-PRS0053	Multi-Unit Impression Coping, Open-Tray .048" Hex	11
70-1050-COM0088	30° Multi-Unit Abutment 4.5 mmH RP	29	70-1074-PRS0052	Multi-Unit Impression Coping, Open-Tray .050" Hex	11
<b>(NobelReplace®)</b>					
70-1051-COM0188	Angled Multi-Unit Abutment Screw NP	34	70-1074-PRS0055	Multi-Unit Impression Coping, Open-Tray 1.0 mm Hex	11
70-1051-COM0189	Angled Multi-Unit Abutment Screw RP	34	70-1074-PRS0054	Multi-Unit Impression Coping, Open-Tray SCS	11
70-1051-COM0171	Multi-Unit Abutment 1 mmH NP	34	70-1074-PRS0021	Multi-Unit Impression Coping, Closed-Tray	11
70-1051-COM0174	Multi-Unit Abutment 1 mmH RP	34	70-1074-PRS0057	Multi-Unit Titanium Temporary - Unigrip	11
70-1051-COM0178	Multi-Unit Abutment 1 mmH WP	34	70-1074-PRS0056	Multi-Unit Titanium Temporary .048" Hex	11
70-1051-COM0172	Multi-Unit Abutment 2 mmH NP	34	70-1074-PRS0025	Multi-Unit Titanium Temporary .050" Hex	11
70-1051-COM0175	Multi-Unit Abutment 2 mmH RP	34	70-1074-PRS0059	Multi-Unit Titanium Temporary 1.0 mm Hex	11
70-1051-COM0179	Multi-Unit Abutment 2 mmH WP	34	70-1074-PRS0058	Multi-Unit Titanium Temporary SCS	11
70-1051-COM0173	Multi-Unit Abutment 3 mmH NP	34	70-1074-PRS0016	Multi-Unit Abutment Analog	11
70-1051-COM0176	Multi-Unit Abutment 3 mmH RP	34	70-1074-PRS0028	Multi-Unit Driver	11
70-1051-COM0180	Multi-Unit Abutment 3 mmH WP	34	70-1047-COM0153	Multi-Unit Prosthetic Screw .048" Hex	11
70-1051-COM0177	Multi-Unit Abutment 5 mmH RP	34	70-1072-PRC0014	Multi-Unit Prosthetic Screw .050" Hex	11
70-1051-COM0181	17° Multi-Unit Abutment 2 mmH NP	34	70-1074-PRS0060	Multi-Unit Prosthetic Screw 1.0 mm Hex	11
70-1051-COM0183	17° Multi-Unit Abutment 2 mmH RP	34	70-1052-COM0088	Multi-Unit Prosthetic Screw SCS	11
70-1051-COM0182	17° Multi-Unit Abutment 3 mmH NP	34	70-1072-PRC0043	Multi-Unit Prosthetic Coping, Closed-Tray - Unigrip	11
70-1051-COM0184	17° Multi-Unit Abutment 3 mmH RP	34	70-1074-PRS0069	Multi-Unit Plastic Coping - Unigrip	11
70-1051-COM0185	17° Multi-Unit Abutment 4 mmH RP	34	70-1074-PRS0068	Multi-Unit Plastic Coping .048" Hex	11
70-1051-COM0186	30° Multi-Unit Abutment 4 mmH RP	34	70-1074-PRS0067	Multi-Unit Plastic Coping .050" Hex	11
70-1051-COM0187	30° Multi-Unit Abutment 5 mmH RP	34	70-1074-PRS0071	Multi-Unit Plastic Coping 1.0 mm Hex	11
<b>(Straumann® Bone Level)</b>					
70-1052-COM0087	Angled Multi-Unit Abutment Screw NC/RC	37	70-1074-PRS0070	Multi-Unit Plastic Coping SCS	11
70-1052-COM0074	Multi-Unit Abutment 1.5 mmH NC	37	<b>PROSTHETIC KIT</b>		
70-1052-COM0077	Multi-Unit Abutment 1.5 mmH RC	37	<b>(Inclusive® Tapered Implant System)</b>		
70-1052-COM0075	Multi-Unit Abutment 2.5 mmH NC	37	70-1071-PRS0001	Inclusive® Tapered Implant Prosthetic Kit	41
70-1052-COM0078	Multi-Unit Abutment 2.5 mmH RC	37	<b>SCANNING ABUTMENTS</b>		
70-1052-COM0076	Multi-Unit Abutment 3.5 mmH NC	37	<b>(BIOMET 3i™ Certain®)</b>		
70-1052-COM0079	Multi-Unit Abutment 3.5 mmH RC	37	70-1047-COM0118	Clinical Scanning Abutment, Anterior 3.4 mm	12
70-1052-COM0080	Multi-Unit Abutment 4.5 mmH RC	37	70-1047-COM0119	Clinical Scanning Abutment, Anterior 4.1 mm	12
70-1052-COM0081	17° Multi-Unit Abutment 2.5 mmH NC	37	70-1047-COM0120	Clinical Scanning Abutment, Anterior 5.0 mm	12
70-1052-COM0083	17° Multi-Unit Abutment 2.5 mmH RC	37	70-1047-COM0121	Clinical Scanning Abutment, Anterior 6.0 mm	12
70-1052-COM0082	17° Multi-Unit Abutment 3.5 mmH NC	37	70-1047-COM0187	Clinical Scanning Abutment, Posterior 3.4 mm	12
70-1052-COM0084	17° Multi-Unit Abutment 3.5 mmH RC	37	70-1047-COM0188	Clinical Scanning Abutment, Posterior 4.1 mm	12
70-1052-COM0085	30° Multi-Unit Abutment 3.5 mmH RC	37	70-1047-COM0189	Clinical Scanning Abutment, Posterior 5.0 mm	12
70-1052-COM0086	30° Multi-Unit Abutment 4.5 mmH RC	37	70-1047-COM0190	Clinical Scanning Abutment, Posterior 6.0 mm	12
<b>MULTI-UNIT ABUTMENT ACCESSORIES</b>					
<b>(Inclusive® Tapered Implant System)</b>					
70-1074-PRS0044	Multi-Unit Temporary Healing Cap - Unigrip	11	70-1047-COM0175	Laboratory Scanning Abutment (3/pk) 3.4 mm	12
70-1074-PRS0043	Multi-Unit Temporary Healing Cap .048" Hex	11	70-1047-COM0176	Laboratory Scanning Abutment (3/pk) 4.1 mm	12
70-1074-PRS0015	Multi-Unit Temporary Healing Cap .050" Hex	11	70-1047-COM0177	Laboratory Scanning Abutment (3/pk) 5.0 mm	12
70-1074-PRS0046	Multi-Unit Temporary Healing Cap 1.0 mm Hex	11	70-1047-COM0178	Laboratory Scanning Abutment (3/pk) 6.0 mm	12
70-1074-PRS0045	Multi-Unit Temporary Healing Cap SCS	11	70-1047-COM0200	Laboratory Scanning Abutment, Blue (3/pk) 3.4 mm	12
70-1074-PRS0048	Multi-Unit Coping 4.5 mmH, Non-Engag - Unigrip	11	70-1047-COM0201	Laboratory Scanning Abutment, Blue (3/pk) 4.1 mm	12
70-1074-PRS0047	Multi-Unit Coping 4.5 mmH, Non-Engag .048" Hex	11	70-1047-COM0202	Laboratory Scanning Abutment, Blue (3/pk) 5.0 mm	12
70-1073-PRA0037	Multi-Unit Coping 4.5 mmH, Non-Engag .050" Hex	11	70-1047-COM0203	Laboratory Scanning Abutment, Blue (3/pk) 6.0 mm	12
70-1074-PRS0050	Multi-Unit Coping 4.5 mmH, Non-Engag 1.0 mm	11	<b>(GAMLOG® SCREW-LINE)</b>		
70-1074-PRS0049	Multi-Unit Coping 4.5 mmH, Non-Engag SCS	11	70-1135-CAM0092	Clinical Scanning Abutment, Anterior 3.3 mm	16
			70-1135-CAM0093	Clinical Scanning Abutment, Anterior 3.8 mm	16
			70-1135-CAM0094	Clinical Scanning Abutment, Anterior 4.3 mm	16
			70-1135-CAM0095	Clinical Scanning Abutment, Anterior 5.0 mm	16



# Parts Index

CODE	DESCRIPTION	PAGE	CODE	DESCRIPTION	PAGE
70-1135-CAM0096	Clinical Scanning Abutment, Anterior 6.0 mm	16	70-1056-COM0015	Laboratory Scanning Abutment, Blue (3/pk) 4.0 mm	24
70-1135-CAM0182	Clinical Scanning Abutment, Posterior 3.3 mm	16	<b>(Nobel Biocare Brånemark System®)</b>		
70-1135-CAM0183	Clinical Scanning Abutment, Posterior 3.8 mm	16	70-1049-COM0041	Clinical Scanning Abutment, Anterior RP	25
70-1135-CAM0184	Clinical Scanning Abutment, Posterior 4.3 mm	16	70-1049-COM0067	Clinical Scanning Abutment, Posterior RP	25
70-1135-CAM0185	Clinical Scanning Abutment, Posterior 5.0 mm	16	70-1049-COM0065	Laboratory Scanning Abutment (3/pk) RP	25
70-1135-CAM0186	Clinical Scanning Abutment, Posterior 6.0 mm	16	70-1049-COM0072	Laboratory Scanning Abutment, Blue (3/pk) RP	25
70-1135-CAM0172	Laboratory Scanning Abutment (3/pk) 3.3 mm	16	<b>(NobelActive®)</b>		
70-1135-CAM0173	Laboratory Scanning Abutment (3/pk) 3.8 mm	16	70-1050-COM0066	Clinical Scanning Abutment, Anterior NP	27
70-1135-CAM0174	Laboratory Scanning Abutment (3/pk) 4.3 mm	16	70-1050-COM0067	Clinical Scanning Abutment, Anterior RP	27
70-1135-CAM0175	Laboratory Scanning Abutment (3/pk) 5.0 mm	16	70-1050-COM0109	Clinical Scanning Abutment, Posterior NP	27
70-1135-CAM0176	Laboratory Scanning Abutment (3/pk) 6.0 mm	16	70-1050-COM0110	Clinical Scanning Abutment, Posterior RP	27
70-1135-CAM0197	Laboratory Scanning Abutment, Blue (3/pk) 3.3 mm	16	70-1050-COM0105	Laboratory Scanning Abutment (3/pk) NP	27
70-1135-CAM0198	Laboratory Scanning Abutment, Blue (3/pk) 3.8 mm	16	70-1050-COM0106	Laboratory Scanning Abutment (3/pk) RP	27
70-1135-CAM0199	Laboratory Scanning Abutment, Blue (3/pk) 4.3 mm	16	70-1050-COM0135	Laboratory Scanning Abutment, Blue (3/pk) NP	27
70-1135-CAM0200	Laboratory Scanning Abutment, Blue (3/pk) 5.0 mm	16	70-1050-COM0136	Laboratory Scanning Abutment, Blue (3/pk) RP	27
70-1135-CAM0201	Laboratory Scanning Abutment, Blue (3/pk) 6.0 mm	16	<b>(NobelReplace®)</b>		
<b>(DENTSPLY Implants ASTRA TECH Implant System®)</b>			70-1051-COM0158	Clinical Scanning Abutment, Anterior 6.0	30
70-1048-COM0124	Clinical Scanning Abutment, Anterior 3.0	20	70-1051-COM0155	Clinical Scanning Abutment, Anterior NP	30
70-1048-COM0125	Clinical Scanning Abutment, Anterior 3.5/4.0	20	70-1051-COM0156	Clinical Scanning Abutment, Anterior RP	30
70-1048-COM0126	Clinical Scanning Abutment, Anterior 4.5/5.0	20	70-1051-COM0157	Clinical Scanning Abutment, Anterior WP	30
70-1048-COM0179	Clinical Scanning Abutment, Posterior 3.0	20	70-1051-COM0232	Clinical Scanning Abutment, Posterior 6.0	31
70-1048-COM0180	Clinical Scanning Abutment, Posterior 3.5/4.0	20	70-1051-COM0229	Clinical Scanning Abutment, Posterior NP	31
70-1048-COM0181	Clinical Scanning Abutment, Posterior 4.5/5.0	20	70-1051-COM0230	Clinical Scanning Abutment, Posterior RP	31
70-1048-COM0173	Laboratory Scanning Abutment (3/pk) 3.0	20	70-1051-COM0231	Clinical Scanning Abutment, Posterior WP	31
70-1048-COM0174	Laboratory Scanning Abutment (3/pk) 3.5/4.0	20	70-1051-COM0218	Laboratory Scanning Abutment (3/pk) 6.0	31
70-1048-COM0175	Laboratory Scanning Abutment (3/pk) 4.5/5.0	20	70-1051-COM0215	Laboratory Scanning Abutment (3/pk) NP	31
70-1048-COM0188	Laboratory Scanning Abutment, Blue (3/pk) 3.0	20	70-1051-COM0216	Laboratory Scanning Abutment (3/pk) RP	31
70-1048-COM0189	Laboratory Scanning Abutment, Blue (3/pk) 3.5/4.0	20	70-1051-COM0217	Laboratory Scanning Abutment (3/pk) WP	31
70-1048-COM0190	Laboratory Scanning Abutment, Blue (3/pk) 4.5/5.0	20	70-1051-COM0260	Laboratory Scanning Abutment, Blue (3/pk) 6.0	31
<b>(Inclusive® Tapered Implant System)</b>			70-1051-COM0257	Laboratory Scanning Abutment, Blue (3/pk) NP	31
70-1073-PRA0051	Clinical Scanning Abutment, Anterior, 3.0 mmP	7	70-1051-COM0258	Laboratory Scanning Abutment, Blue (3/pk) RP	31
70-1073-PRA0042	Clinical Scanning Abutment, Anterior, 3.5 mmP	7	70-1051-COM0259	Laboratory Scanning Abutment, Blue (3/pk) WP	31
70-1073-PRA0043	Clinical Scanning Abutment, Anterior, 4.5 mmP	7	<b>(Straumann® Bone Level)</b>		
70-1073-PRA0050	Clinical Scanning Abutment, Posterior, 3.0 mmP	7	70-1052-COM0066	Clinical Scanning Abutment, Anterior NC	35
70-1073-PRA0040	Clinical Scanning Abutment, Posterior, 3.5 mmP	7	70-1052-COM0067	Clinical Scanning Abutment, Anterior RC	35
70-1073-PRA0041	Clinical Scanning Abutment, Posterior, 4.5 mmP	7	70-1052-COM0109	Clinical Scanning Abutment, Posterior NC	35
70-1073-PRA0049	Laboratory Scanning Abutment 3.0 mmP (3/pk)	7	70-1052-COM0110	Clinical Scanning Abutment, Posterior RC	35
70-1073-PRA0033	Laboratory Scanning Abutment 3.5 mmP (3/pk)	7	70-1052-COM0101	Laboratory Scanning Abutment (3/pk) NC	35
70-1073-PRA0034	Laboratory Scanning Abutment 4.5 mmP (3/pk)	7	70-1052-COM0102	Laboratory Scanning Abutment (3/pk) RC	35
70-1073-PRA0039	Laboratory Scanning Abutment Kit Red	42	70-1052-COM0135	Laboratory Scanning Abutment, Blue (3/pk) NC	35
70-1073-PRA0061	Laboratory Scanning Abutment Kit Blue	42	70-1052-COM0136	Laboratory Scanning Abutment, Blue (3/pk) RC	35
<b>(Keystone Dental PrimaConnex®)</b>			<b>(Straumann® Tissue Level)</b>		
70-1055-COM0018	Clinical Scanning Abutment, Anterior RD	24	70-1053-COM0043	Clinical Scanning Abutment, Posterior RN synOcta	38
70-1055-COM0017	Clinical Scanning Abutment, Anterior SD	24	70-1053-COM0044	Clinical Scanning Abutment, Posterior WN synOcta	38
70-1055-COM0019	Clinical Scanning Abutment, Anterior WD	24	70-1053-COM0041	Laboratory Scanning Abutment (3/pk) RN synOcta	38
70-1055-COM0036	Clinical Scanning Abutment, Posterior RD	24	70-1053-COM0042	Laboratory Scanning Abutment (3/pk) WN synOcta	38
70-1055-COM0035	Clinical Scanning Abutment, Posterior SD	24	70-1053-COM0087	Laboratory Scanning Abutment, Blue (3/pk) RN synOcta	38
70-1055-COM0037	Clinical Scanning Abutment, Posterior WD	24	70-1053-COM0088	Laboratory Scanning Abutment, Blue (3/pk) WN synOcta	38
70-1055-COM0030	Laboratory Scanning Abutment (3/pk) RD	24	<b>(Zimmer Dental Screw-Vent®)</b>		
70-1055-COM0029	Laboratory Scanning Abutment (3/pk) SD	24	70-1054-COM0088	Clinical Scanning Abutment, Anterior 3.5 mm	39
70-1055-COM0031	Laboratory Scanning Abutment (3/pk) WD	24	70-1054-COM0089	Clinical Scanning Abutment, Anterior 4.5 mm	39
70-1055-COM0045	Laboratory Scanning Abutment, Blue (3/pk) RD	24	70-1054-COM0090	Clinical Scanning Abutment, Anterior 5.7 mm	39
70-1055-COM0044	Laboratory Scanning Abutment, Blue (3/pk) SD	24	70-1054-COM0115	Clinical Scanning Abutment, Posterior 3.5 mm	39
70-1055-COM0046	Laboratory Scanning Abutment, Blue (3/pk) WD	24	70-1054-COM0116	Clinical Scanning Abutment, Posterior 4.5 mm	39
<b>(Neoss®)</b>			70-1054-COM0117	Clinical Scanning Abutment, Posterior 5.7 mm	39
70-1056-COM0006	Clinical Scanning Abutment, Anterior 4.0 mm	24	70-1054-COM0106	Laboratory Scanning Abutment (3/pk) 3.5 mm	39
70-1056-COM0012	Clinical Scanning Abutment, Posterior 4.0 mm	24	70-1054-COM0107	Laboratory Scanning Abutment (3/pk) 4.5 mm	39
70-1056-COM0010	Laboratory Scanning Abutment (3/pk) 4.0 mm	24	70-1054-COM0108	Laboratory Scanning Abutment (3/pk) 5.7 mm	39

# Parts Index

CODE	DESCRIPTION	PAGE	CODE	DESCRIPTION	PAGE
70-1054-COM0151	Laboratory Scanning Abutment, Blue (3/pk) 3.5 mm	39	70-1047-COM0006	Titanium Abutment 6 mmH 4.1 mm	13
70-1054-COM0152	Laboratory Scanning Abutment, Blue (3/pk) 4.5 mm	39	70-1047-COM0007	Titanium Abutment 6 mmH 5.0 mm	13
70-1054-COM0153	Laboratory Scanning Abutment, Blue (3/pk) 5.7 mm	39	70-1047-COM0008	Titanium Abutment 6 mmH 6.0 mm	13
<b>TEMPORARY ABUTMENTS</b>					
<b>(Inclusive® Tapered Implant System)</b>					
70-1073-PRA0048	Temporary Abutment 3.0 mmP	7	<b>(CAMLOG® SCREW-LINE)</b>		
70-1073-PRA0022	Temporary Abutment 3.5 mmP	7	70-1135-CAM0012	Titanium Abutment 4.5 mmH 3.3 mm	17
70-1073-PRA0024	Temporary Abutment 4.5 mmP	7	70-1135-CAM0014	Titanium Abutment 4.5 mmH 3.8 mm	17
70-1073-PRA0047	Temporary Abutment, Non-Engag, 3.0 mmP	7	70-1135-CAM0016	Titanium Abutment 4.5 mmH 4.3 mm	17
70-1073-PRA0023	Temporary Abutment, Non-Engag, 3.5 mmP	7	70-1135-CAM0018	Titanium Abutment 4.5 mmH 5.0 mm	17
70-1073-PRA0025	Temporary Abutment, Non-Engag, 4.5 mmP	7	70-1135-CAM0020	Titanium Abutment 4.5 mmH 6.0 mm	17
<b>TITANIUM ABUTMENT BLANKS</b>					
<b>(BIOMET 3i™ Certain®)</b>					
70-1047-COM0054	Titanium Abutment Blank 3.4 mm	14	70-1135-CAM0022	Titanium Abutment 4.5 mmH, Non-Engag, 3.3 mm	17
70-1047-COM0055	Titanium Abutment Blank 4.1 mm	14	70-1135-CAM0024	Titanium Abutment 4.5 mmH, Non-Engag, 3.8 mm	17
70-1047-COM0056	Titanium Abutment Blank 5.0 mm	14	70-1135-CAM0026	Titanium Abutment 4.5 mmH, Non-Engag, 4.3 mm	17
70-1047-COM0057	Titanium Abutment Blank 6.0 mm	14	70-1135-CAM0028	Titanium Abutment 4.5 mmH, Non-Engag, 5.0 mm	17
<b>(CAMLOG® SCREW-LINE)</b>					
70-1135-CAM0117	Titanium Abutment Blank 3.3 mm	18	70-1135-CAM0030	Titanium Abutment 4.5 mmH, Non-Engag, 6.0 mm	17
70-1135-CAM0118	Titanium Abutment Blank 3.8 mm	18	70-1135-CAM0032	Titanium Abutment 6 mmH 3.3 mm	17
70-1135-CAM0119	Titanium Abutment Blank 4.3 mm	18	70-1135-CAM0034	Titanium Abutment 6 mmH 3.8 mm	17
70-1135-CAM0120	Titanium Abutment Blank 5.0 mm	18	70-1135-CAM0036	Titanium Abutment 6 mmH 4.3 mm	17
70-1135-CAM0121	Titanium Abutment Blank 6.0 mm	18	70-1135-CAM0038	Titanium Abutment 6 mmH 5.0 mm	17
<b>(DENTSPLY Implants ASTRA TECH Implant System®)</b>					
70-1048-COM0064	Titanium Abutment Blank 3.0	21	70-1135-CAM0040	Titanium Abutment 6 mmH 6.0 mm	17
70-1048-COM0065	Titanium Abutment Blank 3.5/4.0	21	<b>(DENTSPLY Implants ASTRA TECH Implant System®)</b>		
70-1048-COM0066	Titanium Abutment Blank 4.5/5.0	21	70-1048-COM0089	Titanium Abutment 4.5 mmH 3.0	21
<b>(Nobel Biocare Brånemark System®)</b>					
70-1049-COM0016	Titanium Abutment Blank RP	25	70-1048-COM0091	Titanium Abutment 4.5 mmH 3.5/4.0	21
<b>(NobelActive®)</b>					
70-1050-COM0029	Titanium Abutment Blank NP	28	70-1048-COM0093	Titanium Abutment 4.5 mmH 4.5/5.0	21
70-1050-COM0030	Titanium Abutment Blank RP	28	70-1048-COM0097	Titanium Abutment 4.5 mmH, Non-Engag, 3.5/4.0	21
<b>(NobelReplace®)</b>					
70-1051-COM0055	Titanium Abutment Blank 6.0	32	70-1048-COM0099	Titanium Abutment 4.5 mmH, Non-Engag, 4.5/5.0	21
70-1051-COM0056	Titanium Abutment Blank NP	32	70-1048-COM0004	Titanium Abutment 6 mmH 3.0	21
70-1051-COM0057	Titanium Abutment Blank RP	32	70-1048-COM0005	Titanium Abutment 6 mmH 3.5/4.0	21
70-1051-COM0058	Titanium Abutment Blank WP	32	70-1048-COM0006	Titanium Abutment 6 mmH 4.5/5.0	21
<b>(Straumann® Bone Level)</b>					
70-1052-COM0030	Titanium Abutment Blank NC	36	<b>(Inclusive® Tapered Implant System)</b>		
70-1052-COM0031	Titanium Abutment Blank RC	36	70-1073-PRA0052	Titanium Abutment 3.0 mmP x 4.5 mmH	8
<b>(Zimmer Dental Screw-Vent®)</b>					
70-1054-COM0041	Titanium Abutment Blank 3.5 mm	40	70-1073-PRA0053	Titanium Abutment 3.0 mmP x 6 mmH	8
70-1054-COM0042	Titanium Abutment Blank 4.5 mm	40	70-1073-PRA0006	Titanium Abutment 3.5 mmP x 6 mmH	8
70-1054-COM0043	Titanium Abutment Blank 5.7 mm	40	70-1073-PRA0008	Titanium Abutment 4.5 mmP x 6 mmH	8
<b>TITANIUM ABUTMENTS</b>					
<b>(BIOMET 3i™ Certain®)</b>					
70-1047-COM0084	Titanium Abutment 4.5 mmH 3.4 mm	13	<b>(Nobel Biocare Brånemark System®)</b>		
70-1047-COM0086	Titanium Abutment 4.5 mmH 4.1 mm	13	70-1049-COM0024	Titanium Abutment 4.5 mmH RP	25
70-1047-COM0088	Titanium Abutment 4.5 mmH 5.0 mm	13	70-1049-COM0026	Titanium Abutment 4.5 mmH, Non-Engag, RP	25
70-1047-COM0090	Titanium Abutment 4.5 mmH 6.0 mm	13	70-1049-COM0002	Titanium Abutment 6 mmH RP	25
70-1047-COM0092	Titanium Abutment 4.5 mmH, Non-Engag, 3.4 mm	13	<b>(NobelActive®)</b>		
70-1047-COM0094	Titanium Abutment 4.5 mmH, Non-Engag, 4.1 mm	13	70-1050-COM0046	Titanium Abutment 4.5 mmH NP	27
70-1047-COM0096	Titanium Abutment 4.5 mmH, Non-Engag, 5.0 mm	13	70-1050-COM0048	Titanium Abutment 4.5 mmH RP	27
70-1047-COM0098	Titanium Abutment 4.5 mmH, Non-Engag, 6.0 mm	13	70-1050-COM0050	Titanium Abutment 4.5 mmH, Non-Engag, NP	27
70-1047-COM0005	Titanium Abutment 6 mmH 3.4 mm	13	70-1050-COM0052	Titanium Abutment 4.5 mmH, Non-Engag, RP	27
<b>(NobelReplace®)</b>					
70-1051-COM0088.....Titanium Abutment 4.5 mmH 6.0.....32					
70-1051-COM0090.....Titanium Abutment 4.5 mmH NP.....32					
70-1051-COM0092.....Titanium Abutment 4.5 mmH RP.....32					
70-1051-COM0094.....Titanium Abutment 4.5 mmH WP.....32					
70-1051-COM0096.....Titanium Abutment 4.5 mmH, Non-Engag, 6.0.....32					
70-1051-COM0098.....Titanium Abutment 4.5 mmH, Non-Engag, NP.....32					
70-1051-COM0100.....Titanium Abutment 4.5 mmH, Non-Engag, RP.....32					
70-1051-COM0102.....Titanium Abutment 4.5 mmH, Non-Engag, WP.....32					
70-1051-COM0047.....Titanium Abutment 6 mmH 6.0.....32					
70-1051-COM0048.....Titanium Abutment 6 mmH NP.....32					
70-1051-COM0049.....Titanium Abutment 6 mmH RP.....32					
70-1051-COM0050.....Titanium Abutment 6 mmH WP.....32					

# Parts Index

CODE	DESCRIPTION	PAGE	CODE	DESCRIPTION	PAGE
<b>(Straumann® Bone Level)</b>					
70-1052-COM0045	Titanium Abutment 4.5 mmH NC	35	70-1073-PRA0059	15° Ti. Esthetic Abut., Anterior, 3.0 mmP x 2.3 mmH	8
70-1052-COM0047	Titanium Abutment 4.5 mmH RC	35	70-1073-PRA0009	15° Ti. Esthetic Abut., Anterior, 3.5 mmP	8
70-1052-COM0049	Titanium Abutment 4.5 mmH, Non-Engag, NC	36	70-1073-PRA0010	15° Ti. Esthetic Abut., Anterior, 4.5 mmP	8
70-1052-COM0051	Titanium Abutment 4.5 mmH, Non-Engag, RC	36	70-1073-PRA0013	15° Ti. Esthetic Abut., Posterior, 4.5 mmP	8
70-1052-COM0003	Titanium Abutment 6 mmH NC	35	70-1073-PRA0055	Ti. Esthetic Abut., Anterior 3.0 mmP x 1.5 mmH	8
70-1052-COM0004	Titanium Abutment 6 mmH RC	35	70-1073-PRA0060	Ti. Esthetic Abut., Anterior 3.0 mmP x 2.3 mmH	8
<b>(Straumann® Tissue Level)</b>					
70-1053-COM0057	Titanium Abutment 4.5 mmH, Non-Engag, RN synOcta	38	70-1073-PRA0011	Ti. Esthetic Abut., Anterior 3.5 mmP	8
70-1053-COM0058	Titanium Abutment 4.5 mmH, Non-Engag, WN synOcta	38	70-1073-PRA0012	Ti. Esthetic Abut., Anterior 4.5 mmP	8
<b>(Zimmer Dental Screw-Vent®)</b>					
70-1054-COM0063	Titanium Abutment 4.5 mmH 3.5 mm	40	70-1073-PRA0014	Ti. Esthetic Abut., Posterior 4.5 mmP	8
70-1054-COM0065	Titanium Abutment 4.5 mmH 4.5 mm	40	70-1073-PRA0015	Ti. Esthetic Abut., Posterior, Wide 4.5 mmP	8
70-1054-COM0067	Titanium Abutment 4.5 mmH 5.7 mm	40	<b>(NobelActive®)</b>		
70-1054-COM0069	Titanium Abutment 4.5 mmH, Non-Engag, 3.5 mm	40	70-1050-COM0091	15° Ti. Esthetic Abut., Anterior NP	28
70-1054-COM0071	Titanium Abutment 4.5 mmH, Non-Engag, 4.5 mm	40	70-1050-COM0092	15° Ti. Esthetic Abut., Anterior RP	28
70-1054-COM0073	Titanium Abutment 4.5 mmH, Non-Engag, 5.7 mm	40	70-1050-COM0093	15° Ti. Esthetic Abut., Posterior RP	28
70-1054-COM0004	Titanium Abutment 6 mmH 3.5 mm	40	70-1050-COM0094	Ti. Esthetic Abut., Anterior NP	28
70-1054-COM0005	Titanium Abutment 6 mmH 4.5 mm	40	70-1050-COM0095	Ti. Esthetic Abut., Anterior RP	28
70-1054-COM0006	Titanium Abutment 6 mmH 5.7 mm	40	70-1050-COM0096	Ti. Esthetic Abut., Posterior RP	28
<b>TITANIUM ESTHETIC ABUTMENTS</b>					
<b>(BIOMET 3i™ Certain®)</b>					
70-1047-COM0154	15° Ti. Esthetic Abut., Anterior 3.4 mm	13	<b>(NobelReplace®)</b>		
70-1047-COM0155	15° Ti. Esthetic Abut., Anterior 4.1 mm	13	70-1051-COM0190	15° Ti. Esthetic Abut., Anterior NP	32
70-1047-COM0156	15° Ti. Esthetic Abut., Anterior 5.0 mm	13	70-1051-COM0191	15° Ti. Esthetic Abut., Anterior RP	32
70-1047-COM0157	15° Ti. Esthetic Abut., Posterior 4.1 mm	13	70-1051-COM0192	15° Ti. Esthetic Abut., Anterior WP	32
70-1047-COM0158	15° Ti. Esthetic Abut., Posterior 5.0 mm	13	70-1051-COM0193	15° Ti. Esthetic Abut., Posterior RP	32
70-1047-COM0159	Ti. Esthetic Abut., Anterior 3.4 mm	14	70-1051-COM0194	15° Ti. Esthetic Abut., Posterior WP	32
70-1047-COM0160	Ti. Esthetic Abut., Anterior 4.1 mm	14	70-1051-COM0195	Ti. Esthetic Abut., Anterior NP	32
70-1047-COM0161	Ti. Esthetic Abut., Anterior 5.0 mm	14	70-1051-COM0196	Ti. Esthetic Abut., Anterior RP	32
70-1047-COM0162	Ti. Esthetic Abut., Posterior 4.1 mm	14	70-1051-COM0197	Ti. Esthetic Abut., Anterior WP	32
70-1047-COM0163	Ti. Esthetic Abut., Posterior 5.0 mm	14	70-1051-COM0200	Ti. Esthetic Abut., Posterior 6.0	32
70-1047-COM0164	Ti. Esthetic Abut., Posterior 6.0 mm	14	70-1051-COM0198	Ti. Esthetic Abut., Posterior RP	32
<b>(CAMLOG® SCREW-LINE)</b>					
70-1135-CAM0148	15° Ti. Esthetic Abut., Anterior 3.3 mm	18	70-1051-COM0199	Ti. Esthetic Abut., Posterior WP	32
70-1135-CAM0149	15° Ti. Esthetic Abut., Anterior 3.8 mm	18	<b>(Straumann® Bone Level)</b>		
70-1135-CAM0150	15° Ti. Esthetic Abut., Anterior 4.3 mm	18	70-1052-COM0089	15° Ti. Esthetic Abut., Anterior NC	36
70-1135-CAM0151	15° Ti. Esthetic Abut., Posterior 4.3 mm	18	70-1052-COM0090	15° Ti. Esthetic Abut., Anterior RC	36
70-1135-CAM0152	15° Ti. Esthetic Abut., Posterior 5.0 mm	18	70-1052-COM0091	15° Ti. Esthetic Abut., Posterior RC	36
70-1135-CAM0153	Ti. Esthetic Abut., Anterior 3.3 mm	18	70-1052-COM0092	Ti. Esthetic Abut., Anterior NC	36
70-1135-CAM0154	Ti. Esthetic Abut., Anterior 3.8 mm	18	70-1052-COM0093	Ti. Esthetic Abut., Anterior RC	36
70-1135-CAM0155	Ti. Esthetic Abut., Anterior 4.3 mm	18	70-1052-COM0094	Ti. Esthetic Abut., Posterior RC	36
70-1135-CAM0156	Ti. Esthetic Abut., Posterior 4.3 mm	18	<b>TITANIUM SCREWS AND GUIDE PINS</b>		
70-1135-CAM0157	Ti. Esthetic Abut., Posterior 5.0 mm	18	<b>(BIOMET 3i™ Certain®)</b>		
<b>(DENTSPLY Implants ASTRA TECH Implant System®)</b>					
70-1048-COM0153	15° Ti. Esthetic Abut., Anterior 3.0	21	70-1047-COM0029	Titanium Screw (5/pk) 3.4/4.1/5.0/6.0 mm	14
70-1048-COM0154	15° Ti. Esthetic Abut., Anterior 3.5/4.0	21	70-1047-COM0117	Titanium Screw 3.4/4.1/5.0/6.0 mm	14
70-1048-COM0155	15° Ti. Esthetic Abut., Anterior 4.5/5.0	21	70-1047-COM0112	Guide Pin (5/pk) 3.4/4.1/5.0/6.0 mm	14
70-1048-COM0156	15° Ti. Esthetic Abut., Posterior 3.5/4.0	21	<b>(CAMLOG® SCREW-LINE)</b>		
70-1048-COM0157	15° Ti. Esthetic Abut., Posterior 4.5/5.0	21	70-1135-CAM0125	Titanium Screw (5/pk) 3.3/3.8/4.3 mm	18
70-1048-COM0158	Ti. Esthetic Abut., Anterior 3.0	21	70-1135-CAM0127	Titanium Screw (5/pk) 5.0/6.0 mm	18
70-1048-COM0159	Ti. Esthetic Abut., Anterior 3.5/4.0	21	70-1135-CAM0124	Titanium Screw 3.3/3.8/4.3 mm	18
70-1048-COM0160	Ti. Esthetic Abut., Anterior 4.5/5.0	21	70-1135-CAM0126	Titanium Screw 5.0/6.0 mm	18
70-1048-COM0161	Ti. Esthetic Abut., Posterior 3.5/4.0	21	70-1135-CAM0064	Guide Pin (5/pk) 3.3/3.8/4.3 mm	19
70-1048-COM0162	Ti. Esthetic Abut., Posterior 4.5/5.0	21	70-1135-CAM0066	Guide Pin (5/pk) 5.0/6.0 mm	19
<b>(Inclusive® Tapered Implant System)</b>					
70-1073-PRA0054	15° Ti. Esthetic Abut., Anterior, 3.0 mmP x 1.5 mmH	8	<b>(DENTSPLY Implants ASTRA TECH Implant System®)</b>		
			70-1048-COM0031	Titanium Screw (5/pk) 3.0	22
			70-1048-COM0033	Titanium Screw (5/pk) 3.5/4.0	22
			70-1048-COM0036	Titanium Screw (5/pk) 4.5/5.0	22
			70-1048-COM0121	Titanium Screw 3.0	22
			70-1048-COM0122	Titanium Screw 3.5/4.0	22
			70-1048-COM0123	Titanium Screw 4.5/5.0	22
			70-1048-COM0110	Guide Pin (5/pk) 3.0	22
			70-1048-COM0112	Guide Pin (5/pk) 3.5/4.0	22

# Parts Index

CODE	DESCRIPTION	PAGE	CODE	DESCRIPTION	PAGE
70-1048-COM0114	.....Guide Pin (5/pk) 4.5/5.0	22	70-1135-CAM0166	.....UCLA Plastic Abutment, Non-Engag, 5.0 mm	18
<b>(Inclusive® Tapered Implant System)</b>			70-1135-CAM0167	.....UCLA Plastic Abutment, Non-Engag, 6.0 mm	18
70-1072-PRC0005	.....Closed-Tray Transfer Screw	9	<b>(DENTSPLY Implants ASTRA TECH Implant System®)</b>		
70-1072-PRC0004	.....Open-Tray Transfer Screw	9	70-1048-COM0163	.....UCLA Plastic Abutment 3.0	22
70-1072-PRC0001	.....Titanium Screw	9	70-1048-COM0164	.....UCLA Plastic Abutment 3.5/4.0	22
70-1072-PRC0003	.....Titanium Screw (5/pk)	9	70-1048-COM0165	.....UCLA Plastic Abutment 4.5/5.0	22
70-1072-PRC0058	.....Titanium Screw 3.0 mmP	9	70-1048-COM0166	.....UCLA Plastic Abutment, Non-Engag, 3.0	22
70-1072-PRC0057	.....Titanium Screw 3.0 mmP (5/pk)	9	70-1048-COM0167	.....UCLA Plastic Abutment, Non-Engag, 3.5/4.0	22
70-1072-PRC0002	.....Guide Pin (5/pk)	9	70-1048-COM0168	.....UCLA Plastic Abutment, Non-Engag, 4.5/5.0	22
70-1072-PRC0056	.....Guide Pin 3.0 mmP (5/pk)	9	<b>(Inclusive® Tapered Implant System)</b>		
<b>(Nobel Biocare Brånemark System®)</b>			70-1073-PRA0056	.....UCLA Gold Abutment 3.0 mmP	9
70-1049-COM0011	.....Titanium Screw (5/pk) RP	26	70-1073-PRA0027	.....UCLA Gold Abutment 3.5 mmP	9
70-1049-COM0040	.....Titanium Screw RP	26	70-1073-PRA0029	.....UCLA Gold Abutment 4.5 mmP	9
<b>(NobelActive®)</b>			70-1073-PRA0058	.....UCLA Plastic Abutment 3.0 mmP	9
70-1050-COM0010	.....Titanium Screw (5/pk) NP	28	70-1073-PRA0018	.....UCLA Plastic Abutment 3.5 mmP	9
70-1050-COM0011	.....Titanium Screw (5/pk) RP	28	70-1073-PRA0020	.....UCLA Plastic Abutment 4.5 mmP	9
70-1050-COM0064	.....Titanium Screw NP	28	70-1073-PRA0057	.....UCLA Plastic Abutment, Non-Engag, 3.0 mmP	9
70-1050-COM0065	.....Titanium Screw RP	28	70-1073-PRA0019	.....UCLA Plastic Abutment, Non-Engag, 3.5 mmP	9
70-1050-COM0060	.....Guide Pin Implant Level 20 mm (5/pk) NP	28	70-1073-PRA0021	.....UCLA Plastic Abutment, Non-Engag, 4.5 mmP	9
70-1050-COM0061	.....Guide Pin Implant Level 20 mm (5/pk) RP	26,28	<b>(Nobel Biocare Brånemark System®)</b>		
<b>(NobelReplace®)</b>			70-1049-COM0063	.....UCLA Plastic Abutment RP	26
70-1051-COM0019	.....Titanium Screw (5/pk) NP	33	70-1049-COM0064	.....UCLA Plastic Abutment, Non-Engag, RP	26
70-1051-COM0020	.....Titanium Screw (5/pk) RP/WP/6.0	33	<b>(NobelActive®)</b>		
70-1051-COM0153	.....Titanium Screw NP	33	70-1050-COM0097	.....UCLA Plastic Abutment NP	28
70-1051-COM0154	.....Titanium Screw RP/WP/6.0	33	70-1050-COM0098	.....UCLA Plastic Abutment RP	28
70-1051-COM0142	.....Guide Pin Implant Level 20 mm (5/pk) NP	33	70-1050-COM0099	.....UCLA Plastic Abutment, Non-Engag, NP	28
70-1051-COM0144	.....Guide Pin Implant Level 20 mm (5/pk) RP/WP/6.0	33	70-1050-COM0100	.....UCLA Plastic Abutment, Non-Engag, RP	28
<b>(Straumann® Bone Level)</b>			<b>(NobelReplace®)</b>		
70-1052-COM0020	.....Titanium Screw (5/pk) NC	36	70-1051-COM0214	.....UCLA Gold Abutment 6.0	33
70-1052-COM0021	.....Titanium Screw (5/pk) RC	36	70-1051-COM0211	.....UCLA Gold Abutment NP	33
70-1052-COM0064	.....Titanium Screw NC	36	70-1051-COM0212	.....UCLA Gold Abutment RP	33
70-1052-COM0065	.....Titanium Screw RC	36	70-1051-COM0213	.....UCLA Gold Abutment WP	33
70-1052-COM0059	.....Guide Pin (5/pk) NC	37	70-1051-COM0204	.....UCLA Plastic Abutment 6.0	33
70-1052-COM0061	.....Guide Pin (5/pk) RC	37	70-1051-COM0201	.....UCLA Plastic Abutment NP	33
<b>(Straumann® Tissue Level)</b>			70-1051-COM0202	.....UCLA Plastic Abutment RP	33
70-1053-COM0009	.....Titanium Basal Screw (5/pk) RN/WN synOcta	38	70-1051-COM0203	.....UCLA Plastic Abutment WP	33
70-1053-COM0034	.....Titanium Basal Screw RN/WN synOcta	38	70-1051-COM0208	.....UCLA Plastic Abutment, Non-Engag, 6.0	33
70-1053-COM0036	.....Titanium Occlusal Screw (5/pk) NN	38	70-1051-COM0205	.....UCLA Plastic Abutment, Non-Engag, NP	33
70-1053-COM0035	.....Titanium Occlusal Screw NN	38	70-1051-COM0206	.....UCLA Plastic Abutment, Non-Engag, RP	33
<b>(Zimmer Dental Screw-Vent®)</b>			70-1051-COM0207	.....UCLA Plastic Abutment, Non-Engag, WP	33
70-1054-COM0022	.....Titanium Screw (5/pk) 3.5/4.5/5.7 mm	40	<b>(Straumann® Bone Level)</b>		
70-1054-COM0048	.....Titanium Screw 3.5/4.5/5.7 mm	40	70-1052-COM0095	.....UCLA Plastic Abutment NC	36
70-1054-COM0084	.....Guide Pin (5/pk) 3.5/4.5/5.7 mm	40	70-1052-COM0096	.....UCLA Plastic Abutment RC	36
<b>UCLA ABUTMENTS</b>			70-1052-COM0097	.....UCLA Plastic Abutment, Non-Engag, NC	36
<b>(BIOMET 3i™ Certain®)</b>			70-1052-COM0098	.....UCLA Plastic Abutment, Non-Engag, RC	36
70-1047-COM0165	.....UCLA Plastic Abutment 3.4 mm	14	<b>(Straumann® Tissue Level)</b>		
70-1047-COM0166	.....UCLA Plastic Abutment 4.1 mm	14	70-1053-COM0037	.....UCLA Gold Abutment RN synOcta	38
70-1047-COM0167	.....UCLA Plastic Abutment 5.0 mm	14	70-1053-COM0038	.....UCLA Gold Abutment WN synOcta	38
70-1047-COM0168	.....UCLA Plastic Abutment 6.0 mm	14	70-1053-COM0039	.....UCLA Gold Abutment, Non-Engag, RN synOcta	38
70-1047-COM0169	.....UCLA Plastic Abutment, Non-Engag, 3.4 mm	14	70-1053-COM0040	.....UCLA Gold Abutment, Non-Engag, WN synOcta	38
70-1047-COM0170	.....UCLA Plastic Abutment, Non-Engag, 4.1 mm	14	<b>(Zimmer Dental Screw-Vent®)</b>		
70-1047-COM0171	.....UCLA Plastic Abutment, Non-Engag, 5.0 mm	14	70-1054-COM0100	.....UCLA Plastic Abutment 3.5 mm	40
70-1047-COM0172	.....UCLA Plastic Abutment, Non-Engag, 6.0 mm	14	70-1054-COM0101	.....UCLA Plastic Abutment 4.5 mm	40
<b>(CAMLOG® SCREW-LINE)</b>			70-1054-COM0102	.....UCLA Plastic Abutment 5.7 mm	40
70-1135-CAM0163	.....UCLA Plastic Abutment, Non-Engag, 3.3 mm	18	70-1054-COM0103	.....UCLA Plastic Abutment, Non-Engag, 3.5 mm	40
70-1135-CAM0164	.....UCLA Plastic Abutment, Non-Engag, 3.8 mm	18	70-1054-COM0104	.....UCLA Plastic Abutment, Non-Engag, 4.5 mm	40
70-1135-CAM0165	.....UCLA Plastic Abutment, Non-Engag, 4.3 mm	18	70-1054-COM0105	.....UCLA Plastic Abutment, Non-Engag, 5.7 mm	40



## Product Packaging

Inclusive Prosthetic Components are delivered in boxed blister trays or heat-sealed plastic pouches. They may be stored in a dry location at room temperature in this original packaging. Please refer to the individual product label for all relevant product information and cautions. Products labeled **STERILE** are suspended inside shrink-wrapped vials, and are intended for single-use only, prior to the expiration date. Do not use sterile products if the packaging has been compromised or previously opened. Do not re-sterilize. Products labeled **NON-STERILE** should be cleaned, disinfected, and sterilized according to a validated method prior to use in the oral environment.

### Explanation of Label Codes:

1. Official product description
2. Product image
3. Reference number (product code)
4. Lot number
5. By prescription only
6. Do not use if tampered with
7. Gamma sterilization symbol
8. Expiration date
9. Consult Instructions for Use (IFU)
10. Do not re-sterilize
11. For single-use only
12. Manufacturer
13. Country of origin
14. FDA Unique Device Identification (UDI)
15. Non-Sterile
16. Notified body number
17. European Authorized Representative
18. Date of manufacture

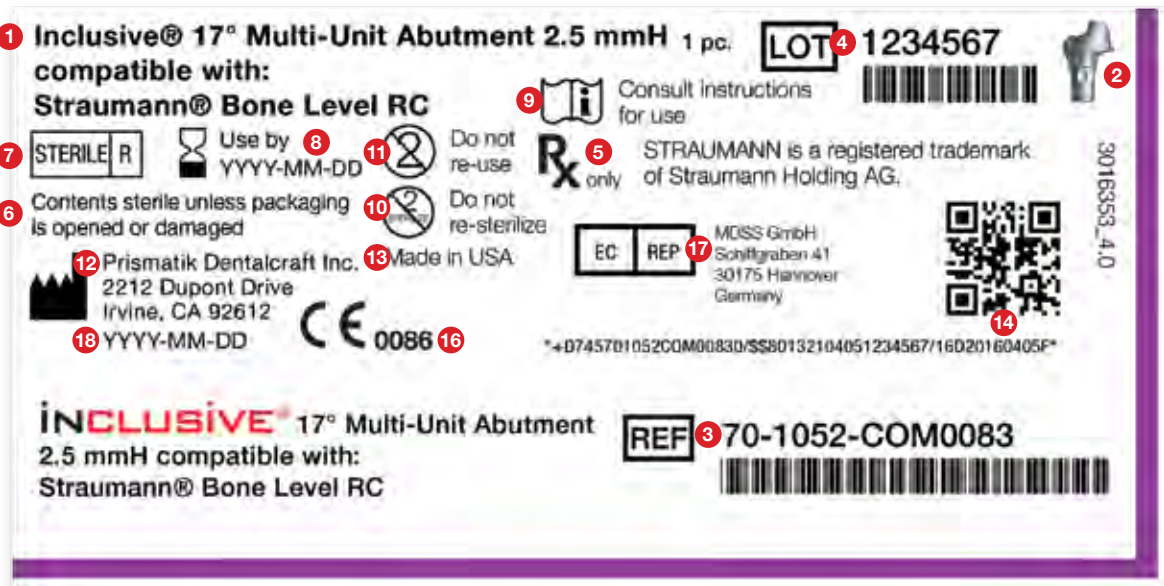

---

## Policies and Warranty

---

### ***Product Return Policy***

Products may be returned at the customer's expense for credit within 30 days of invoice date. All returned products must meet the following conditions:

- A copy of the original invoice must accompany the products.
- Products must be packaged to arrive at the seller's facility undamaged.
- Discontinued, obsolete, expired, damaged, or opened items will not be accepted for return.
- Amount credited will be based on invoice price, less 15 percent for restocking fee.
- Shipping charges are the responsibility of the customer and will not be credited.

### ***Product & Pricing Changes***

Because products and equipment are continually undergoing refinement in design and manufacturing methods, we reserve the right to improve, modify, or discontinue products and equipment or change pricing at any time without incurring any obligation and without prior notice.

### ***Warranty***

Limited Warranty—Prismatik Dentalcraft, Inc.

Prismatik Dentalcraft, Inc. ("Prismatik"), is the manufacturer of dental products (the "product"), including Inclusive® Dental Implants ("implants"). For a period from the original purchase date of seven (7) years for implants and six (6) months for ceramic blanks and any other product ("the warranty period"), Prismatik will at its option replace or refund the purchase price of any product, to the original purchaser ("user"), that is returned due to defects in material and manufacture.

**NO GUARANTEE OR WARRANTY IS IMPLIED OTHER THAN EXPRESSLY STATED, INCLUDING ANY IMPLIED WARRANTY OF MERCHANTABILITY OR FITNESS FOR A PARTICULAR PURPOSE.**

Prismatik shall not be liable for any incidental or consequential damages, whether foreseeable or not, caused by defects in the product or dental devices produced using said product. User is responsible for determining the suitability of the product for user's application. If this product is defective within the warranty period, user's exclusive remedy and Prismatik's sole obligation shall be replacement or refund of the purchase price of the product. For replacement or refund under this warranty, the original purchaser shall send the product at its own expense, postage prepaid, to the seller.

**INCLUSIVE**<sup>®</sup>  
PROSTHETIC COMPONENTS



SECTION A-A  
SCALE



Designed & Manufactured in the USA  
by



**PRISMATIK  
DENTALCRAFT, INC.**

(A wholly owned subsidiary of Glidewell Laboratories)  
2212 Dupont Dr. • Irvine, CA 92612

**CE** 0086

**EC** **REP**

**MDSS GmbH**  
Schiffgraben 41  
30175 Hannover, Germany

MKT 1419\_3.0  
REV ID: 1344

GD-812-042916